



Orthotic Product Catalogue

Issue 22

Blatchford Patient Solutions offer a wide range of high-quality stock products to meet a variety of clinical pathways and patient expectations. By combining clinical expertise with innovative stock products, we have developed several strong working partnerships with UK and international companies to ensure we provide the best rehabilitation and mobility solutions. Our goal is to deliver excellence in service, delivery, quality, and cost via the products we distribute in the UK Orthotic market.

In addition to this our team of highly skilled technicians manufacture modular and custom devices to ensure optimal benefit to the user. Our specialisations include orthotic devices for diabetes, neurological disorders, orthopaedics, and spinal pathologies. We also offer modular and custom orthopaedic footwear from paediatric to geriatric provision.

Blatchford

Contents

Preferred Suppliers	4
Ordering Information	5
Turtlebrace	6
Turbomed XTERN	8
Foot and Ankle	13
Knee Braces	93
Hip	121
Wrist, Elbow and Shoulder	125
Spinal Supports	155
Hernia	175
Maternity	183
Cervical	187
Head Protection	197
Contracture Devices	203
Paediatric	209



Ordering Information

1. Ordering:

Ordering products from Blatchford is simple and easy. You can contact our Customer Services directly:

Telephone: +44 (0) 114 2637900

Email: orthoticscs@blatchford.co.uk

Facsimile: +44 (0) 114 2637901

Post: Blatchford Limited, 11 Atlas Way, Atlas North, Sheffield, S4 7QQ.

2. Delivery Promise:

Our goal is to provide a fast and efficient delivery. Therefore our aim is to despatch all orders for internal stock products, received by 2pm Monday to Thursday and by 11am on Fridays, on the day the order is received. This does not apply where specific delivery schedules have been previously agreed and is subject to stock availability.

3. Single Patient Use

All products prescribed/distributed by Blatchford are for single patient use only and should be fitted by a qualified health care professional. The re-use of any product can potentially cause harm to the user and will invalidate the CE or any warranty agreement.

All user mass, activity levels and load bearing are stipulated according to the manufacturer's IFU.

Some products in the catalogue may contain leather, please refer to the manufacturer's IFU.

4. Warranty

All products are covered by a manufacturer's warranty please refer to the product IFU or contact a member of our customer service team. All products supplied by Blatchford conform to MDD or MDR regulations.

5. Catalogues/Product Information:

If you require additional product information please contact our customer service advisors who will be happy to help with your enquiry.

6. Delivery Charges for Mainland UK

Standard delivery time = next working day by 5.30pm £7.50. N.B. Standard delivery charges are per order not per item.

All delivery charges are + VAT.

These charges do not apply where prior agreement has been made in respect of delivery.

7. Shortages/Damaged Goods:

If any items are received damaged or there are shortages in the delivery this must be notified to customer services within 5 days of receipt of goods.

8. Blatchford Returns Policy:

In the event of a product being returned for credit this must be done within 30 days of receipt.

In the event a product has been supplied faulty or incorrectly our customer service team need to be notified within 5 working days of receipt so that replacement goods can be despatched or processed for credit.

We are happy to accept 'stock products' that are returned for credit if they are not suitable for the patient. For items to be accepted for credit the following conditions apply:

- The product must not have been adapted
- Are returned in the original packaging and not defaced
- Are in a re-saleable condition and unworn

Blatchford reserves the right to reject items returned for credit if the above conditions are not met. Blatchford are unable to accept return of items that are 'made to order' for credit, unless the goods are faulty, or it can be demonstrated they have been damaged in transit.

All items being returned for credit must be received within 30 days in accordance with the above return's conditions.

Please note items not stocked by Blatchford may take up to 7 days to be replaced.

Products & prices are subject to variation at any time and are subject to availability. E & OE.

If you need more information, please contact our customer service depart on 01142637900 or emailorthoticscs@blatchford.co.uk

9. Bespoke Custom Manufacturing Service

In addition to our comprehensive stock range, we also manufacture a wide range of fully bespoke solutions using the latest CAD-CAM and 3D printing technologies, to complement this we also use traditional hand skills.

All our bespoke products are manufactured in the UK at our Central Orthotic manufacturing facility in Sheffield.

Bespoke products include:

- Helmets
- AFOs
- KAFOs
- Spinal Bracing
- Cervical
- Insoles
- Bespoke/Modular Footwear
- Footwear adaption/repair

If you have any questions regarding the products in this brochure please contact Customer Services on +44 (0) 114 2637900 or alternatively email orthoticscs@blatchford.co.uk

All products are distributed by Blatchford in accordance with supplier agreements.

Trademarks contained in this catalogue are the intellectual property of the manufacturer and are not associated to Blatchford.

Turtlebrace

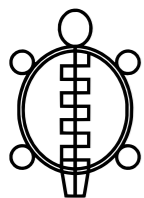
 All you need in a brace - visit turtlebrace.com

The original Turtlebrace prototype was first developed in 2015. The quality and efficiency of the product were quickly recognised, leading to industry demand that transformed the prototype into a company, which was officially founded in 2017.

Turtlebrace are dedicated to creating, optimising and producing high quality products that meet the needs of the health professional and the patient's quality of life. Their products are sold throughout four continents.

Product Features and Benefits

- Supports and enables rehab protocol - doesn't limit it
- The only brace available that fits newborn up to adults
- 100% made in North America
- Cares for the environment - uses minimal packaging
- Licensed health Canada manufacturer
- Direct molding on the limb
- Antibacterial fabric
- Radio-transparent
- Submersible and auto-draining
- Remoldable without limits nor degradation
- 3.2 mm thickness that permits normal dressing
- Compostable eco-friendly plastic

3 Simple Steps for Use

1. Heat the brace (dry heat or hot water), until it becomes soft and elastic.

Dry heat method

Put the brace in either the Turtlebrace heating bag, a regular or convection oven, between 67°C and 108°C (152°F and 225°F).

Hot water method

Place the brace in a hot-water heating pan, between 67 °C and 100°C (152°F and 212°F)

2. Once the brace has become soft and elastic, you can drape the brace on the body. Make sure that the temperature of the brace is not too hot for comfort or at risk of burning your patient.

3. Place your patient in the desired position and wait for the brace to harden.

Turtlebrace Baby

- 'Apply and forget' type brace made of a stratification of multi-perforated low-temperature thermoplastic and microfibre fabric
- Flexibility of components stabilises joint more easily and precisely than a traditional brace or cast
- Can be reshaped multiple times, without losing its qualities - allows adjustment due to swelling or morphological changes

Turtlebrace Baby

Age/Size	Product Code	Calf Circumference	Ankle Circumference	Height
1 Month	TBBC-01	Min: 12.6cm Max: 15.8cm	Min: 10.8cm Max: 13.4cm	11cm
6 Months	TBBC-02	Min: 16.2cm Max: 20.5cm	Min: 12.6cm Max: 15.8cm	15cm
18 Months	TBBC-03	Min: 19.8cm Max: 25.1cm	Min: 14.4cm Max: 18.1cm	19cm



Turtlebrace Ankle

- 'Apply and forget' type brace made of a stratification of multi-perforated low-temperature thermoplastic and microfibre fabric
- Flexibility of components stabilises joint more easily and precisely than a traditional brace or cast
- Can be reshaped multiple times, without losing its qualities - allows adjustment due to swelling or morphological changes

Turtlebrace Ankle

Size	Product Code - Standard	Product Code - Reinforced	Ankle Circumference
Paediatric - Small	TBCP-01	N/A	16.5cm - 27.6cm
Paediatric - Medium	TBCP-02	TBCPR-02	17.8cm - 29.8cm
Paediatric - Large	TBCP-03	TBCPR-03	19cm - 31.8cm
Adult - Small	TBCA-01	TBCAR-01	20.3cm - 34cm
Adult - Medium	TBCA-02	TBCAR-02	21.6cm - 36.2cm
Adult - Large	TBCA-03	TBCAR-03	22.9cm - 38.4cm



Turtlebrace Wrist

- 'Apply and forget' type brace made of a stratification of multi-perforated low-temperature thermoplastic and microfibre fabric
- Flexibility of components stabilises joint more easily and precisely than a traditional brace or cast
- Can be reshaped multiple times, without losing its qualities - allows adjustment due to swelling or morphological changes

Turtlebrace Wrist

Size	Product Code - Hook and Loop	Product Code - Zipper	Wrist Circumference
Paediatric - Medium	TBPPV-02	TBPPZ-02	10.4cm - 16.6cm
Paediatric - Large	TBPPV-03	TBPPZ-03	12.8cm - 20.5cm
Adult - Small	TBPAV-01	TBPAZ-01	15.2cm - 24.3cm
Adult - Medium	TBPAV-02	TBPAZ-02	17.6cm - 28.2cm
Adult - Large	TBPAV-03	TBPAZ-03	20cm - 32cm



Turtlebrace Elbow

- 'Apply and forget' type brace made of a stratification of multi-perforated low-temperature thermoplastic and microfibre fabric
- Flexibility of components stabilises joint more easily and precisely than a traditional brace or cast
- Can be reshaped multiple times, without losing its qualities - allows adjustment due to swelling or morphological changes

Turtlebrace Elbow

Age/Size	Product Code	Arm Circumference	Wrist Circumference	Total Length
1 month	TBBCo-01	Min: 10.8cm Max: 13.4cm	Min: 9cm Max: 11.1cm	13.5cm
6 months	TBBCo-02	Min: 13cm Max: 16.3cm	Min: 9.9cm Max: 12.3cm	17.3cm
18 months	TBBCo-03	Min: 14.4cm Max: 18.1cm	Min: 10.8cm Max: 13.4cm	21.3cm
3 years	TBBCo-04	Min: 15.3cm Max: 19.3cm	Min: 11.7cm Max: 14.6cm	25.5cm
5 years	TBCoP-01	Min: 16.2cm Max: 20.5cm	Min: 12.2cm Max: 15.3cm	28.9cm
7 years	TBCoP-02	Min: 17.2cm Max: 21.8cm	Min: 12.6cm Max: 15.8cm	32.4cm
9 years	TBCoP-03	Min: 18.3cm Max: 23.2cm	Min: 13.1cm Max: 16.4cm	36.0cm
11 years	TBCoP-04	Min: 19.9cm Max: 25.3cm	Min: 13.5cm Max: 17cm	39.7cm
Adult - Small	TBCoA-01	Min: 21.7cm Max: 27.6cm	Min: 14cm Max: 17.6cm	43.4cm
Adult - Medium	TBCoA-02	Min: 26.1cm Max: 33.3cm	Min: 14.4cm Max: 18.1cm	43.7cm
Adult - Large	TBCoA-03	Min: 32.4cm Max: 41.5cm	Min: 16.2cm Max: 20.5cm	44.1cm

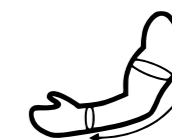

Turtlebrace Finger Add-ons

- Auto-fusing finger extension that can be applied on the popular Turtlebrace wrist or the Harebrace wrist
- Unique design facilitates immobilisation where required
- Flexibility of components stabilises fingers more easily and precisely than a traditional brace or cast
- Can be cut to fit
- Can be reshaped multiple times, without losing its qualities - allows adjustment due to morphological changes or specific protocols
- Universal size
- Universal Finger Splint can be used to splint fractured fingers when a wrist brace is not required

Turtlebrace Finger Add-ons

Size	Product Code - Fingers	Product Code - Thumb
Universal	EDUA	EPUA



Turtlebrace Finger Splint

Size	Product Code
Universal	DUA



Meet the Xtern Family



Which Xtern is right for you?

100% dynamic AFO	✓	✓	✓
No skin contact	✓	✓	✓
Symmetrical design that fits left and right shoes	✓	✓	✓
Conforms to uneven ground and slopes	✓	✓	✓
Lace clip technology that allows fast installation from shoe to shoe	✓	✓	✓
Number of lace clips included	5	10	10
Warranty on plastic and/or carbon fibre parts	2 years	3 years	2 years



See through design that is almost invisible when worn.

- ✓ 25% lighter*
- ✓ 18% more dorsi flexion power*
- ✓ 35% more medial lateral strength*

Designed for patients with reduced dexterity and hand mobility. such as stroke patients.

- ✓ Anterior shell
- ✓ Unique front leg design
- ✓ Easy rear entry thanks to revolutionary frontal design
- ✓ Magnetised hook and look strap is easily attached with one hand
- ✓ 25% more medial lateral stability*

Distributed by



XTERN: The New Revolutionary Foot Drop AFO

Designed in Canada • Assembled in the UK • Distributed by Blatchford



No skin contact
Exoskeleton design fits onto the outside of the shoe without touching the foot or the ankle.



Adaptable
Easily conforms to uneven ground and slopes.



Symmetrical design
Fits both the left and right feet.



Turbomed XTERN AFO Fully Assembled

Amazing energy return

Patented design makes it easy to position yourself, as well as invert or evert the foot as required.



Lightweight, sleek design

Made of highly durable thermoplastic that makes it feel weightless.



Versatile

Goes from shoe to shoe in 5 seconds. Fits majority of shoes.



Turbomed XTERN AFO

- Exoskeleton design fits onto the outside of the shoe
- No skin contact with foot or ankle
- Energy return due to patented design
- Easily conforms to uneven ground and slopes
- Highly durable thermoplastic (2 year warranty)
- Heat adjustable (to change width and dorsiflexion strength)
- Easily transferable from shoe to shoe
- Symmetrical design, fits both right and left feet
- Easily positioned to invert or evert the foot as required



Ankle Stabilisation Strap



Extension Stopper Kit



Lace Clip Attachment



AT-X Assessment Tool



Heel Bumper Kit



Tie Wrap

Turbomed XTERN AT-X Assessment Tool

Product Code	Size
109100-AT-P	Paediatric
109100-AT-S	Small
109100-AT-M	Medium
109100-AT-L	Large
109100-TK-SML	Small/Medium/Large

Accessories

Description	Product Code	Size
Ankle Stabilisation Strap	500100-AST-SML	Small/Medium/Large
Extension Stopper Height 30mm	500202-EXT-030	Small/Medium/Large
Extension Stopper Height 40mm	500202-EXT-040	Small/Medium/Large
Extension Stopper Height 45mm	500202-EXT-045	Small/Medium/Large
Lace Clip Attachment	200000-L00-P	Paediatric
Lace Clip Attachment	200000-L00-S	Small
Lace Clip Attachment	200000-L00-ML	Medium/Large
Tie-Wrap Black 18 Lbs-4"	700000-ZZZ-001	Pack of 20 Units
Tie-Wrap Black 18 Lbs-4"	700000-ZZZ-002	Pack of 1000 Units
Heel Bumper Kit	500250-HBP-SML	Small/Medium/Large



Turbomed XTERN Classic AFO

- Exoskeleton design fits onto the outside of the shoe
- No skin contact with foot or ankle
- Energy return due to patented design
- Easily conforms to uneven ground and slopes
- Highly durable thermoplastic (2 year warranty)
- Heat adjustable (to change width and dorsiflexion strength)
- Easily transferable from shoe to shoe
- Symmetrical design, fits both right and left feet
- Easily positioned to invert or evert the foot as required
- Approx weight 300 grams

Turbomed Classic AFO Fully Assembled

Product Code	Size
XTERN-FA/P	Paediatric
XTERN-FA/S	Small
XTERN-FA/M	Medium
XTERN-FA/L	Large

Accessories

Description	Product Code	Size
XTERN Classic Calf Pad and Strap Kit	500301-K00-P	Paediatric
XTERN Classic Calf Pad and Strap Kit	500302-K00-SML	Small/Medium/Large

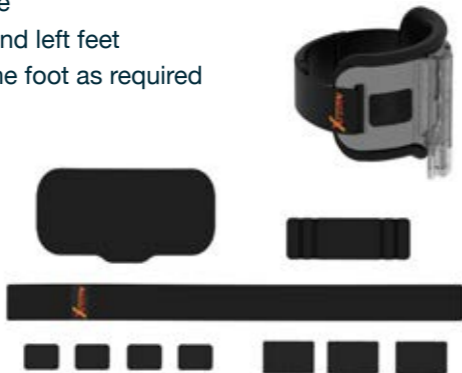

Turbomed XTERN Summit AFO

- Exoskeleton design fits onto the outside of the shoe
- No skin contact with foot or ankle
- Sleek patented design
- Improved pad strap design
- 35% more medial/lateral stability
- 18% more dorsi flexion power
- Easily conforms to uneven ground and slopes
- Highly durable Carbon fibre and thermoplastic material (3 year warranty)
- Easily transferable from shoe to shoe
- Symmetrical design, fits both right and left feet
- Easily positioned to invert or evert the foot as required
- Approx weight 250 grams

Turbomed Summit AFO Fully Assembled

Product Code	Size
Summit-FA/S	Small
Summit-FA/M	Medium
Summit-FA/L	Large

Accessories

Description	Product Code	Size
Summit Xtern Moulded Calf Pad/Strap	501302-K00-S	Small
Summit Xtern Moulded Calf Pad/Strap	501302-K00-ML	Medium/Large



Turbomed XTERN Frontier AFO

- Exoskeleton design fits onto the outside of the shoe
- Anterior shell design with rear entry
- 25% more medial/lateral stability
- Magnatised strap system
- No skin contact with foot or ankle
- Easily conforms to uneven ground and slopes
- Highly durable thermoplastic material (2 year warranty)
- Easily transferable from shoe to shoe
- Symmetrical design, fits both right and left feet
- Easily positioned to invert or evert the foot as required
- Approx weight 400 grams

Turbomed Frontier AFO Fully Assembled

Product Code	Size
Frontier-FA/S	Small
Frontier-FA/M	Medium
Frontier-FA/L	Large

Accessories

Description	Product Code	Size
Frontier Shin Pad/Mag Strap Kit	502400-K00-SML	Small/Medium/Large





Foot and Ankle

Flensburg Available direct from UK stock

Features

- Asymmetric, spacious diabetic shoe
- Available in standard and wide fittings
- Dorsal zip allows donning and doffing without using the hook and loop fasteners.
- Integrated toe cap for additional stability and protection
- 30mm thick, rigid and extra strong rocker bottom sole with pitch prevents flexion of the metatarsophalangeal joints, ensuring the patient's foot is stabilised and immobilised
- Each shoe is supplied with three 5mm thick EVA insoles (STANDARD FO0053-XX and WIDE FO0054-XX). The top insole has an antimicrobial coating. The insoles can be used as an interim solution for pressure relief until being replaced with a diabetic foot orthotic.

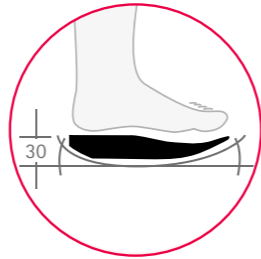

Dresden Available direct from UK stock

Features

- Asymmetric, spacious diabetic shoe
- Available in standard and wide fittings
- The firm outer fabric can be separated from the soft inner fabric to eliminate possible pressure points
- 30mm thick, rigid and extra strong rocker bottom sole with pitch prevents flexion of the metatarsophalangeal joints, ensuring the patient's foot is stabilised and immobilised
- Supplied with a cutting template but without insoles. If insoles are required please see insole sets on page 18.

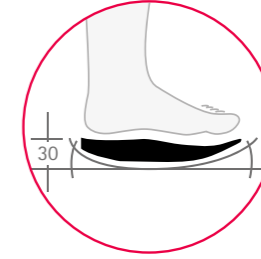

Flensburg Standard

Size	Product Code (Pair)	Product Code (Left)	Product Code (Right)
35	TS5311-35	TS5311-35/L	TS5311-35/R
36	TS5311-36	TS5311-36/L	TS5311-36/R
37	TS5311-37	TS5311-37/L	TS5311-37/R
38	TS5311-38	TS5311-38/L	TS5311-38/R
39	TS5311-39	TS5311-39/L	TS5311-39/R
40	TS5311-40	TS5311-40/L	TS5311-40/R
41	TS5311-41	TS5311-41/L	TS5311-41/R
42	TS5311-42	TS5311-42/L	TS5311-42/R
43	TS5311-43	TS5311-43/L	TS5311-43/R
44	TS5311-44	TS5311-44/L	TS5311-44/R
45	TS5311-45	TS5311-45/L	TS5311-45/R
46	TS5311-46	TS5311-46/L	TS5311-46/R
47	TS5311-47	TS5311-47/L	TS5311-47/R
48	TS5311-48	TS5311-48/L	TS5311-48/R
49	TS5311-49	TS5311-49/L	TS5311-49/R
50	TS5311-50	TS5311-50/L	TS5311-50/R

Flensburg Wide

Size	Product Code (Pair)	Product Code (Left)	Product Code (Right)
35	TS5911-35	TS5911-35/L	TS5911-35/R
36	TS5911-36	TS5911-36/L	TS5911-36/R
37	TS5911-37	TS5911-37/L	TS5911-37/R
38	TS5911-38	TS5911-38/L	TS5911-38/R
39	TS5911-39	TS5911-39/L	TS5911-39/R
40	TS5911-40	TS5911-40/L	TS5911-40/R
41	TS5911-41	TS5911-41/L	TS5911-41/R
42	TS5911-42	TS5911-42/L	TS5911-42/R
43	TS5911-43	TS5911-43/L	TS5911-43/R
44	TS5911-44	TS5911-44/L	TS5911-44/R
45	TS5911-45	TS5911-45/L	TS5911-45/R
46	TS5911-46	TS5911-46/L	TS5911-46/R
47	TS5911-47	TS5911-47/L	TS5911-47/R
48	TS5911-48	TS5911-48/L	TS5911-48/R
49	TS5911-49	TS5911-49/L	TS5911-49/R
50	TS5911-50	TS5911-50/L	TS5911-50/R

Dresden Standard

Size	Product Code (Pair)	Product Code (Left)	Product Code (Right)
35	TS5811-35	TS5811-35/L	TS5811-35/R
36	TS5811-36	TS5811-36/L	TS5811-36/R
37	TS5811-37	TS5811-37/L	TS5811-37/R
38	TS5811-38	TS5811-38/L	TS5811-38/R
39	TS5811-39	TS5811-39/L	TS5811-39/R
40	TS5811-40	TS5811-40/L	TS5811-40/R
41	TS5811-41	TS5811-41/L	TS5811-41/R
42	TS5811-42	TS5811-42/L	TS5811-42/R
43	TS5811-43	TS5811-43/L	TS5811-43/R
44	TS5811-44	TS5811-44/L	TS5811-44/R
45	TS5811-45	TS5811-45/L	TS5811-45/R
46	TS5811-46	TS5811-46/L	TS5811-46/R
47	TS5811-47	TS5811-47/L	TS5811-47/R
48	TS5811-48	TS5811-48/L	TS5811-48/R

Dresden Wide

Size	Product Code (Pair)	Product Code (Left)	Product Code (Right)
35	TS5411-35	TS5411-35/L	TS5411-35/R
36	TS5411-36	TS5411-36/L	TS5411-36/R
37	TS5411-37	TS5411-37/L	TS5411-37/R
38	TS5411-38	TS5411-38/L	TS5411-38/R
39	TS5411-39	TS5411-39/L	TS5411-39/R
40	TS5411-40	TS5411-40/L	TS5411-40/R
41	TS5411-41	TS5411-41/L	TS5411-41/R
42	TS5411-42	TS5411-42/L	TS5411-42/R
43	TS5411-43	TS5411-43/L	TS5411-43/R
44	TS5411-44	TS5411-44/L	TS5411-44/R
45	TS5411-45	TS5411-45/L	TS5411-45/R
46	TS5411-46	TS5411-46/L	TS5411-46/R
47	TS5411-47	TS5411-47/L	TS5411-47/R
48	TS5411-48	TS5411-48/L	TS5411-48/R

Nürnberg Available direct from UK stock

Features

- Asymmetric, spacious diabetic shoe
- Available in standard and wide fittings
- The firm outer fabric can be separated from the soft inner fabric to avoid possible pressure points
- 30mm thick, rigid and extra strong rocker bottom sole with pitch prevents flexion of the metatarsophalangeal joints, ensuring the patient's foot is stabilised and immobilised
- Supplied with a cutting template but without insoles. If insoles are required please see insole sets on page 18.

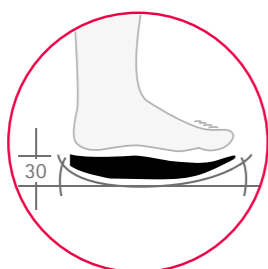

Nurnberg Standard

Size	Product Code (Pair)	Product Code (Left)	Product Code (Right)
35	TS4311-35	TS4311-35/L	TS4311-35/R
36	TS4311-36	TS4311-36/L	TS4311-36/R
37	TS4311-37	TS4311-37/L	TS4311-37/R
38	TS4311-38	TS4311-38/L	TS4311-38/R
39	TS4311-39	TS4311-39/L	TS4311-39/R
40	TS4311-40	TS4311-40/L	TS4311-40/R
41	TS4311-41	TS4311-41/L	TS4311-41/R
42	TS4311-42	TS4311-42/L	TS4311-42/R
43	TS4311-43	TS4311-43/L	TS4311-43/R
44	TS4311-44	TS4311-44/L	TS4311-44/R
45	TS4311-45	TS4311-45/L	TS4311-45/R
46	TS4311-46	TS4311-46/L	TS4311-46/R
47	TS4311-47	TS4311-47/L	TS4311-47/R
48	TS4311-48	TS4311-48/L	TS4311-48/R

Nurnberg Wide

Size	Product Code (Pair)	Product Code (Left)	Product Code (Right)
35	TS4411-35	TS4411-35/L	TS4411-35/R
36	TS4411-36	TS4411-36/L	TS4411-36/R
37	TS4411-37	TS4411-37/L	TS4411-37/R
38	TS4411-38	TS4411-38/L	TS4411-38/R
39	TS4411-39	TS4411-39/L	TS4411-39/R
40	TS4411-40	TS4411-40/L	TS4411-40/R
41	TS4411-41	TS4411-41/L	TS4411-41/R
42	TS4411-42	TS4411-42/L	TS4411-42/R
43	TS4411-43	TS4411-43/L	TS4411-43/R
44	TS4411-44	TS4411-44/L	TS4411-44/R
45	TS4411-45	TS4411-45/L	TS4411-45/R
46	TS4411-46	TS4411-46/L	TS4411-46/R
47	TS4411-47	TS4411-47/L	TS4411-47/R
48	TS4411-48	TS4411-48/L	TS4411-48/R



Kassel Available direct from UK stock

Features

- Asymmetric, spacious diabetic shoe
- Available in standard and wide fittings
- The firm outer fabric can be separated from the soft inner fabric to avoid possible pressure points
- Protective forefoot cap can be attached to the toe area to keep the foot dry and warm
- 30mm thick, rigid and extra strong rocker bottom sole with pitch prevents flexion of the metatarsophalangeal joints, ensuring the patient's foot is stabilised and immobilised
- Supplied with a cutting template but without insoles. If insoles are required please see insole sets on page 18.

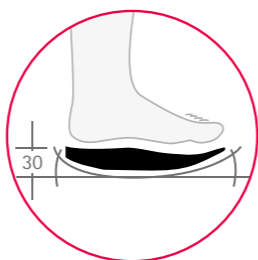

Kassel Standard

Size	Product Code (Pair)	Product Code (Left)	Product Code (Right)
35	TS5421-35	TS5421-35/L	TS5421-35/R
36	TS5421-36	TS5421-36/L	TS5421-36/R
37	TS5421-37	TS5421-37/L	TS5421-37/R
38	TS5421-38	TS5421-38/L	TS5421-38/R
39	TS5421-39	TS5421-39/L	TS5421-39/R
40	TS5421-40	TS5421-40/L	TS5421-40/R
41	TS5421-41	TS5421-41/L	TS5421-41/R
42	TS5421-42	TS5421-42/L	TS5421-42/R
43	TS5421-43	TS5421-43/L	TS5421-43/R
44	TS5421-44	TS5421-44/L	TS5421-44/R
45	TS5421-45	TS5421-45/L	TS5421-45/R
46	TS5421-46	TS5421-46/L	TS5421-46/R
47	TS5421-47	TS5421-47/L	TS5421-47/R
48	TS5421-48	TS5421-48/L	TS5421-48/R

Kassel Wide

Size	Product Code (Pair)	Product Code (Left)	Product Code (Right)
35	TS5321-35	TS5321-35/L	TS5321-35/R
36	TS5321-36	TS5321-36/L	TS5321-36/R
37	TS5321-37	TS5321-37/L	TS5321-37/R
38	TS5321-38	TS5321-38/L	TS5321-38/R
39	TS5321-39	TS5321-39/L	TS5321-39/R
40	TS5321-40	TS5321-40/L	TS5321-40/R
41	TS5321-41	TS5321-41/L	TS5321-41/R
42	TS5321-42	TS5321-42/L	TS5321-42/R
43	TS5321-43	TS5321-43/L	TS5321-43/R
44	TS5321-44	TS5321-44/L	TS5321-44/R
45	TS5321-45	TS5321-45/L	TS5321-45/R
46	TS5321-46	TS5321-46/L	TS5321-46/R
47	TS5321-47	TS5321-47/L	TS5321-47/R
48	TS5321-48	TS5321-48/L	TS5321-48/R

Protective Forefoot Cap Available direct from UK stock

Features

- Easily attached to Kassel Standard and Wide
- Keeps the foot dry and warm

Protective Forefoot Cap

Size	Product Code	Size	Product Code
35-36	FO9520-XXS	43-44	FO9520-L
37-38	FO9520-XS	45-46	FO9520-XL
39-40	FO9520-S	47-48	FO9520-XXL
41-42	FO9520-M		



Bremen Available direct from UK stock

Particularly suited for patients with wounds at the foot/forefoot area on the sole of the foot.

Features

- Spacious post-op shoe with a generous instep fastener for easier donning and doffing
- Integrated toe cap for added stability and protection
- Universal, fits left or right
- 30mm thick, rigid and extra strong rocker bottom sole with pitch
- Supplied with an antimicrobial coated EVA insole



Bremen

Size	Inner Shoe Dimensions		Product Code
	A	C	
XXS	89	209	TS1151-XXS
XS	92	230	TS1151-XS
S	100	236	TS1151-S
M	102	254	TS1151-M
L	106	268	TS1151-L
XL	109	285	TS1151-XL
XXL	110	301	TS1151-XXL

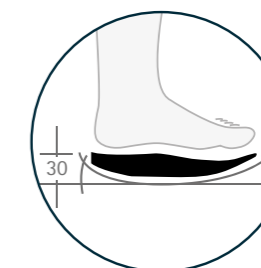

Erfurt Available direct from UK stock

Particularly suited for patients with wounds at the foot/forefoot area on the sole of the foot, swellings or joint pain. Also suitable for those who need a closed shoe with a fastener system offering wider, more generous opening and a tall shaft.

Features

- Asymmetric, spacious post-op shoe with a generous instep fastener
- Available in standard and wide fittings
- Dorsal zip for easier donning and doffing
- Integrated toe cap for added stability and protection
- 30mm thick, rigid and extra strong rocker bottom sole with pitch
- Supplied with three 5mm thick antimicrobial coated EVA insoles (Standard FO0053-XX and Wide FO0054-XX)

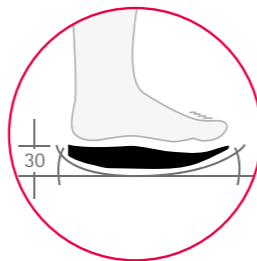

Leipzig Available direct from UK stock

Features

- Asymmetric, spacious diabetic shoe
- Hook and loop fasteners, and dorsal zip, facilitate generously wide opening for easier donning and doffing
- Integrated toe cap for more stability and protection in the toe area
- 30mm thick, flexible sole with pitch supports a natural heel to toe movement while walking
- Supplied with three 5mm thick antimicrobial coated EVA insoles (FO0053-XX)

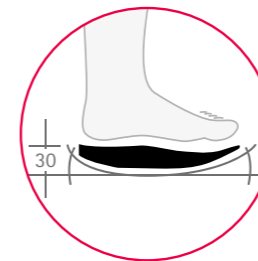

Erfurt Standard			
Size	Product Code (Pair)	Product Code (Left)	Product Code (Right)
35	TS5310-35	TS5310-35/L	TS5310-35/R
36	TS5310-36	TS5310-36/L	TS5310-36/R
37	TS5310-37	TS5310-37/L	TS5310-37/R
38	TS5310-38	TS5310-38/L	TS5310-38/R
39	TS5310-39	TS5310-39/L	TS5310-39/R
40	TS5310-40	TS5310-40/L	TS5310-40/R
41	TS5310-41	TS5310-41/L	TS5310-41/R
42	TS5310-42	TS5310-42/L	TS5310-42/R
43	TS5310-43	TS5310-43/L	TS5310-43/R
44	TS5310-44	TS5310-44/L	TS5310-44/R
45	TS5310-45	TS5310-45/L	TS5310-45/R
46	TS5310-46	TS5310-46/L	TS5310-46/R
47	TS5310-47	TS5310-47/L	TS5310-47/R
48	TS5310-48	TS5310-48/L	TS5310-48/R
49	TS5310-49	TS5310-49/L	TS5310-49/R
50	TS5310-50	TS5310-50/L	TS5310-50/R

Erfurt Wide			
Size	Product Code (Pair)	Product Code (Left)	Product Code (Right)
35	TS5410-35	TS5410-35/L	TS5410-35/R
36	TS5410-36	TS5410-36/L	TS5410-36/R
37	TS5410-37	TS5410-37/L	TS5410-37/R
38	TS5410-38	TS5410-38/L	TS5410-38/R
39	TS5410-39	TS5410-39/L	TS5410-39/R
40	TS5410-40	TS5410-40/L	TS5410-40/R
41	TS5410-41	TS5410-41/L	TS5410-41/R
42	TS5410-42	TS5410-42/L	TS5410-42/R
43	TS5410-43	TS5410-43/L	TS5410-43/R
44	TS5410-44	TS5410-44/L	TS5410-44/R
45	TS5410-45	TS5410-45/L	TS5410-45/R
46	TS5410-46	TS5410-46/L	TS5410-46/R
47	TS5410-47	TS5410-47/L	TS5410-47/R
48	TS5410-48	TS5410-48/L	TS5410-48/R
49	TS5410-49	TS5410-49/L	TS5410-49/R
50	TS5410-50	TS5410-50/L	TS5410-50/R

Leipzig Standard			
Size	Product Code (Pair)	Product Code (Left)	Product Code (Right)
35	TS5512-35	TS5512-35/L	TS5512-35/R
36	TS5512-36	TS5512-36/L	TS5512-36/R
37	TS5512-37	TS5512-37/L	TS5512-37/R
38	TS5512-38	TS5512-38/L	TS5512-38/R
39	TS5512-39	TS5512-39/L	TS5512-39/R
40	TS5512-40	TS5512-40/L	TS5512-40/R
41	TS5512-41	TS5512-41/L	TS5512-41/R
42	TS5512-42	TS5512-42/L	TS5512-42/R
43	TS5512-43	TS5512-43/L	TS5512-43/R
44	TS5512-44	TS5512-44/L	TS5512-44/R
45	TS5512-45	TS5512-45/L	TS5512-45/R
46	TS5512-46	TS5512-46/L	TS5512-46/R
47	TS5512-47	TS5512-47/L	TS5512-47/R
48	TS5512-48	TS5512-48/L	TS5512-48/R
49	TS5512-49	TS5512-49/L	TS5512-49/R
50	TS5512-50	TS5512-50/L	TS5512-50/R



Heidelberg Available direct from UK stock

Particularly suited to the following risk groups and wound stages of the diabetic foot:

Risk group III: condition after plantar ulcer.

Grade 0: condition after lesion.

Features

- Asymmetric, spacious diabetic shoe
- Provides a variable volume
- Partially flexible upper fabric is elastic and adapts to different demands on space
- 30mm thick, flexible sole with pitch supports a natural heel to toe movement while walking
- Supplied with three 5mm thick antimicrobial coated EVA insoles (FO0053-XX)



Heidelberg Standard

Size	Product Code (Pair)	Product Code (Left)	Product Code (Right)
35	TS4552-35	TS4552-35/L	TS4552-35/R
36	TS4552-36	TS4552-36/L	TS4552-36/R
37	TS4552-37	TS4552-37/L	TS4552-37/R
38	TS4552-38	TS4552-38/L	TS4552-38/R
39	TS4552-39	TS4552-39/L	TS4552-39/R
40	TS4552-40	TS4552-40/L	TS4552-40/R
41	TS4552-41	TS4552-41/L	TS4552-41/R
42	TS4552-42	TS4552-42/L	TS4552-42/R
43	TS4552-43	TS4552-43/L	TS4552-43/R
44	TS4552-44	TS4552-44/L	TS4552-44/R
45	TS4552-45	TS4552-45/L	TS4552-45/R
46	TS4552-46	TS4552-46/L	TS4552-46/R
47	TS4552-47	TS4552-47/L	TS4552-47/R
48	TS4552-48	TS4552-48/L	TS4552-48/R
49	TS4552-49	TS4552-49/L	TS4552-49/R
50	TS4552-50	TS4552-50/L	TS4552-50/R

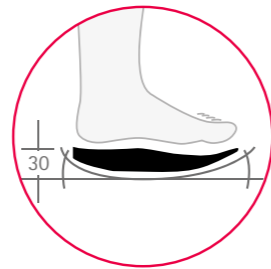

Insole Set Available direct from UK stock

Features

- Antimicrobial top cover
- Manufactured from EVA, providing different shore hardnesses:
Grey = 46° White = 23° Antimicrobial = 28°

Insole Set Standard

Size	Product Code (Left Set)	Product Code (Right Set)
35	FO0053-35/L	FO0053-35/R
36	FO0053-36/L	FO0053-36/R
37	FO0053-37/L	FO0053-37/R
38	FO0053-38/L	FO0053-38/R
39	FO0053-39/L	FO0053-39/R
40	FO0053-40/L	FO0053-40/R
41	FO0053-41/L	FO0053-41/R
42	FO0053-42/L	FO0053-42/R
43	FO0053-43/L	FO0053-43/R
44	FO0053-44/L	FO0053-44/R
45	FO0053-45/L	FO0053-45/R
46	FO0053-46/L	FO0053-46/R
47	FO0053-47/L	FO0053-47/R
48	FO0053-48/L	FO0053-48/R
49	FO0053-49/L	FO0053-49/R
50	FO0053-50/L	FO0053-50/R

Insole Set Wide

Size	Product Code (Left Set)	Product Code (Right Set)
35	FO0054-35/L	FO0054-35/R
36	FO0054-36/L	FO0054-36/R
37	FO0054-37/L	FO0054-37/R
38	FO0054-38/L	FO0054-38/R
39	FO0054-39/L	FO0054-39/R
40	FO0054-40/L	FO0054-40/R
41	FO0054-41/L	FO0054-41/R
42	FO0054-42/L	FO0054-42/R
43	FO0054-43/L	FO0054-43/R
44	FO0054-44/L	FO0054-44/R
45	FO0054-45/L	FO0054-45/R
46	FO0054-46/L	FO0054-46/R
47	FO0054-47/L	FO0054-47/R
48	FO0054-48/L	FO0054-48/R
49	FO0054-49/L	FO0054-49/R
50	FO0054-50/L	FO0054-50/R



EVA Insole Set

- Manufactured from EVA, providing different shore hardnesses:
Black = 40 Grey = 25 White = 50

Insole Set Standard (Fits Flensburg, Heidelberg Leipzig, Kassel and Nurnberg)

Size	Product Code (Left Set)	Product Code (Right Set)
35	FO0033-35/L	FO0033-35/R
36	FO0033-36/L	FO0033-36/R
37	FO0033-37/L	FO0033-37/R
38	FO0033-38/L	FO0033-38/R
39	FO0033-39/L	FO0033-39/R
40	FO0033-40/L	FO0033-40/R
41	FO0033-41/L	FO0033-41/R
42	FO0033-42/L	FO0033-42/R
43	FO0033-43/L	FO0033-43/R
44	FO0033-44/L	FO0033-44/R
45	FO0033-45/L	FO0033-45/R
46	FO0033-46/L	FO0033-46/R
47	FO0033-47/L	FO0033-47/R
48	FO0033-48/L	FO0033-48/R
49	FO0033-49/L	FO0033-49/R
50	FO0033-50/L	FO0033-50/R

Insole Set Wide (Fits Erfurt, Flensburg, Dresden, Leipzig, Kassel, Nurnberg)

Size	Product Code (Left Set)	Product Code (Right Set)
35	FO0034-35/L	FO0034-35/R
36	FO0034-36/L	FO0034-36/R
37	FO0034-37/L	FO0034-37/R
38	FO0034-38/L	FO0034-38/R
39	FO0034-39/L	FO0034-39/R
40	FO0034-40/L	FO0034-40/R
41	FO0034-41/L	FO0034-41/R
42	FO0034-42/L	FO0034-42/R
43	FO0034-43/L	FO0034-43/R
44	FO0034-44/L	FO0034-44/R
45	FO0034-45/L	FO0034-45/R
46	FO0034-46/L	FO0034-46/R
47	FO0034-47/L	FO0034-47/R
48	FO0034-48/L	FO0034-48/R
49	FO0034-49/L	FO0034-49/R
50	FO0034-50/L	FO0034-50/R



Measurement Guide

Standard

(Flensburg, Erfurt Heidelberg and Leipzig)

Size	Inner Shoe Dimensions (mm)		
	A	B	C
35	95	66	227
36	96	67	233
37	98	68	239
38	100	69	246
39	101	70	251
40	102	71	257
41	105	73	266
42	107	74	272
43	108	75	280
44	109	75	288
45	111	76	292
46	112	77	299
47	113	78	304
48	114	79	310
49	116	80	315
50	118	81	320

Standard

(Dresden, Kassel and Nürnberg)

Size	Inner Shoe Dimensions (mm)		
	A	B	C
35	93	63	239
36	94	63	243
37	95	65	248
38	96	66	256
39	99	67	264
40	100	69	268
41	102	70	272
42	104	70	280
43	105	70	290
44	108	72	295
45	108	73	300
46	110	75	306
47	113	75	315
48	113	77	317

Wide

(Flensburg and Erfurt)

Size	Inner Shoe Dimensions (mm)		
	A	B	C
35	105	69	233
36	107	69	240
37	109	70	245
38	110	71	250
39	111	72	255
40	112	73	260
41	112	74	268
42	113	75	273
43	115	76	283
44	120	77	290
45	123	78	295
46	123	78	301
47	125	81	307
48	126	82	315
49	129	84	321
50	130	85	328

Wide

(Dresden, Kassel and Nürnberg)

Size	Inner Shoe Dimensions (mm)		
	A	B	C
35	103	67	243
36	104	68	247
37	105	70	254
38	108	70	259
39	109	71	264
40	109	71	270
41	110	72	276
42	111	73	283
43	113	74	288
44	115	75	295
45	117	76	301
46	118	78	308
47	120	80	313
48	122	82	318

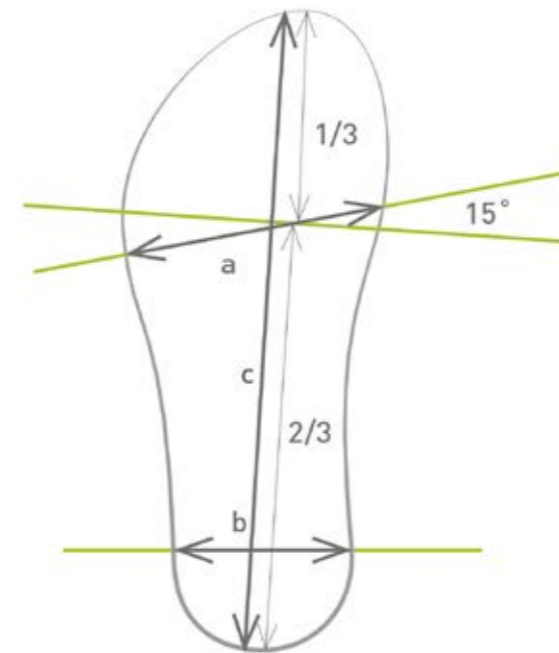

Promedics Post-Op Shoe

- Square toe configuration offers protection and improved fit/ accommodation
- Rocker-sole profile aids gait and reduces forces on foot
- Outsole is non-slip and material composition provides reduced movement under the metatarsal heads
- Simple closure system allows for additional dressings
- Insole can be removed for alteration, improved accommodation or fitting 'Off-Loading Insole'



The coloured graphic depicts the pressure distribution on the sole of the foot.

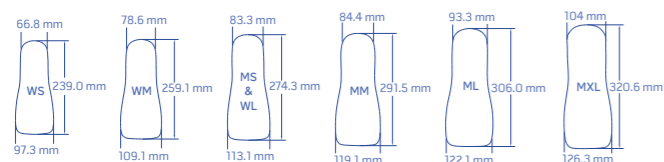

Post-Op Shoe

Mens Size	Product Code	Shoe Size (UK)	Ladies Size	Product Code	Shoe Size (UK)
Small	P-OP/MS	5 - 7	Small	P-OP/WS	3 - 5
Medium	P-OP/MM	7.5 - 9	Medium	P-OP/MM	5.5 - 7
Large	P-OP/ML	9.5 - 11	Large	P-OP/WL	7.5 - 9
Extra Large	P-OP/XL	11.5 - 13			

Promedics Off-loader Heel Shoe

- Hard wearing padded nylon upper
- Adjustable hook/loop fastening
- Hard-wearing sole unit shaped to prevent force on forefoot
- Extendable forefoot closure panel to accommodate dressings padding
- Lower profile wedge
- Insole can be removed for alteration, improved accommodation or fitting 'Off-Loading' Insole



The coloured graphic depicts the pressure distribution on the sole of the foot.

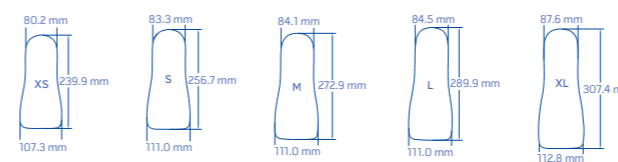

Off-loader Heel Shoe

Size	Product Code	Shoe Size (UK)
Extra Small	OWH/XS	2 - 4
Small	OWH/S	5 - 6
Medium	OWH/M	7 - 8
Large	OWH/L	9 - 11
Extra Large	OWH/XL	12 - 14

Promedics High Post-Op Shoe

- Square toe configuration offers protection and improved fit/accommodation
- Rocker-sole profile aids gait and reduces forces on foot
- Outsole is non-slip and material composition provides reduced movement under the metatarsal heads
- Simple closure system allows for additional dressings
- Insole can be removed for alteration, improved accommodation or fitting 'Off-Loading Insole'
- Adjustable instep strap for improved seating of heel
- Ankle high upper for improved fit and control for patients with compression dressings and total contact casts

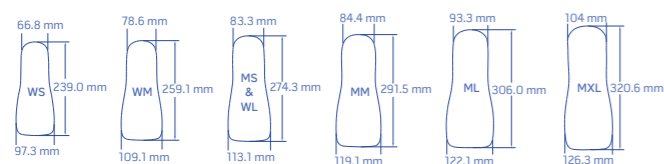

The coloured graphic depicts the pressure distribution on the sole of the foot.

High Post-Op Shoe

Mens Size	Product Code	Shoe Size (UK)	Ladies Size	Product Code	Shoe Size (UK)
Small	HP-OP/MS	5 - 7	Small	HP-OP/WS	3 - 5
Medium	HP-OP/MM	7.5 - 9	Medium	HP-OP/MM	5.5 - 7
Large	HP-OP/ML	9.5 - 11	Large	HP-OP/WL	7.5 - 9
Extra Large	HP-OP/XL	11.5 - 13			

Promedics Off-loading Insoles

- Easily remove sections of insole for custom off-loading in treatment of various foot pathologies
- Greatly reduces pressure on plantar surface when patient is walking
- Self-adhesive stabilising base board
- Available for all post op shoes

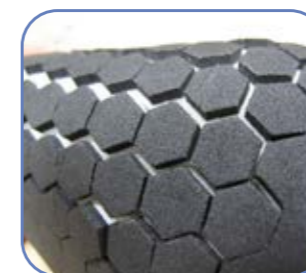

Off-loading Insoles for Post-op and High Post-op Shoes

Mens Size	Product Code	Shoe Size (UK)
Small	P-OP/MSI	5 - 7
Medium	P-OP/MMI	7.5 - 9
Large	P-OP/MLI	9.5 - 11
Extra Large	P-OP/XLI	11.5 - 13

Off-loading Insoles for Off-loader Heel Shoe

Size	Code	Shoe Size (UK)
Extra Small	OWH/XSINS	2-4
Small	OWH/SINS	5-6
Medium	OWH/MINS	7-8
Large	OWH/LINS	9-11
Extra Large	OWH/XLINS	12-14

Promedics Heel Relief Shoe

- Alleviates pressure on the heel
- Comfortably padded
- Insole can be removed for alteration or to accommodate a custom orthotic
- Ankle strap reduces heel slippage
- Removable/adjustable closure to accommodate dressings etc.

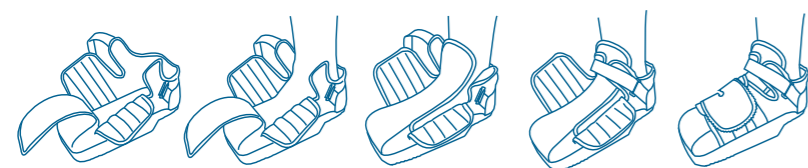

Heel Relief Shoe

Size	Product Code	Ladies Shoe Size (UK)	Mens Shoe Size (UK)
Extra Small	HRS/XS	4 - 7.5	N/A
Small	HRS/S	8 - 10	6 - 7.5
Medium	HRS/M	10.5 - 13	8 - 10
Large	HRS/L	N/A	10.5 - 12
Extra Large	HRS/XL	N/A	12.5 +

Promedics Superstep Post-Op Shoe

- A padded durable nylon upper with return loop buckles
- The upper will accommodate swelling and dressings
- Padded insole with fully rigid, lightweight hard wearing outer sole unit
- The sole unit is designed for improved stability to aid rehabilitation following foot surgery, trauma or any condition that requires immobilisation to aid healing



Superstep Post-Op Shoe

Size	Product Code	Sole Length	Sole Width
Paediatric	RPO/PAED	20cm	8cm
Ladies Small	RPO/WS	24cm	8cm
Ladies Medium	RPO/MM	25cm	9cm
Ladies Large	RPO/WL	27cm	9cm
Mens Small	RPO/MS	28cm	10cm
Mens Medium	RPO/MM	29cm	10cm
Mens Large	RPO/ML	30cm	10cm
Mens Extra Large	RPO/MXL	32cm	11cm

Algeos Darco All Round Long Term Closed Shoe

- A comprehensive relief shoe that can be worn during healing and rehabilitation
- Slip-resistant, sandwich sole
- Light-weight, breathable nylon fabric upper that repels water and soil
- Extra wide opening with adjustable hook and loop closure
- Spacious design accommodates custom insoles or bandages
- Removable insoles
- Universal, left or right



Darco All Round Long Term Closed Shoe

Size	Product Code	Shoe Size (EUR)
Extra Small	NV0766	37 - 38
Small	NV0767	39 - 40
Medium	NV0768	41 - 42
Large	NV0769	43 - 44
Extra Large	NV0770	45 - 46
Extra Extra Large	NV0831	47 - 48

Ossur Post-Op Footwear - DH Pressure Relief Shoe

- Designed around Össur's patented Active Offloading Insole
- Designed to accommodate bulky dressings
- Super-soft nylon upper with reinforced heel counter provides extra comfort and stability
- Patented removable toe piece aides in wound accessibility for daily wound site inspection
- Semi-rigid rocker bottom outsole
- Universal, left or right



Ossur Post-Op Footwear - DH Pressure Relief Shoe

Size	Product Code	Ladies Shoe Size (UK)	Mens Shoe Size (UK)
Small	10340	6.5 - 8.5	4 - 6
Medium	10341	9 - 11	6.5 - 8.5
Large	10342	12+	9 - 11
Extra Large	10343	13+	11.5 - 14



Ossur Evenup Shoelift™

- Used in conjunction with an Össur Walker, the Evenup helps prevent back, hip and knee injuries by leveling a patient's gait
- The only removable, reusable and adjustable shoelift on the market
- Fits right or left shoe.
- Adjustable from 1cm to 2cm lift
- Can also be used as a temporary shoe raise of 1 or 2cm



Ossur Evenup Shoelift™

Size	Product Code
Small	10350 EvenuP (EUS)
Medium	10351 EvenuP (EUM)
Large	10352 EvenuP (EUL)

LGB Medical Bio-Advanced Available direct from Sheffield stock

- Heat mouldable EVA insoles
- 4 degree intrinsic rearfoot support built in
- Contoured arch profile with metatarsal support
- Removeable 1st Met, Ray and Calcaneal EVA Plugs
- Component kit includes:
 - 2 x heel cushions
 - 2 x 4° forefoot wedges (full length only)
 - 2 x 4° rearfoot wedges
 - 2 x 5mm heel lifts
 - 1 x calcaneal dell, 1st metatarsal head and ray replacable plugs (3/4 length only)



Bio-Advance	Product Code
Bio-Advance Full Length Low Density	BIOAF40(+size)
Bio-Advance Full Length Medium Density	BIOAF60(+size)
Bio-Advance Full Length High Density	BIOAF80(+size)*
Bio-Advance 3/4 Length Low Density	BIOAH40(+size)
Bio-Advance 3/4 Length Medium Density	BIOAH60(+size)
Bio-Advance 3/4 Length High Density	BIOAH80(+size)*

Size	KS	K	XS	S	M	L	XL	
Shoe Size (UK)	12-13 (kids)	1-3 (kids)	3-4.5	5-6.5	7-8.5	9-10.5	11-12.5	*Not available in KS or K sizes.

LGB Medical Bio-Skive Available direct from Sheffield stock

- Heat mouldable EVA insoles
- Incorporates 6mm medial heel skive and lowered arch profile for correct pronation
- Standard intrinsic medial 4° rearfoot post to normalise heel strike
- Component kit includes:
 - 2 x heel cushions
 - 2 x 4° forefoot wedges (full length only)
 - 2 x 4° rearfoot wedges
 - 2 x 5mm heel lifts
 - 1 x calcaneal dell, 1st metatarsal head and ray replacable plugs (3/4 length only)



Bio-Slimline	Product Code
Bio-Skive Full Length Low Density	BIOKF40-(+size)
Bio-Skive Full Length Medium Density	BIOKF60-(+size)

Size	XS	S	M	L	XL
Shoe Size (UK)	3 - 4.5	5 - 6.5	7 - 8.5	9 - 10.5	11 - 12.5

LGB Medical Bio-Slimline Available direct from Sheffield stock

(also comes with Component Kit but no forefoot wedge)

- Heat mouldable EVA insoles
- 4 Degree Intrinsic Rearfoot support built in
- Contoured arch profile with metatarsal support
- Removeable 1st Met, Ray and Calcaneal EVA Plugs
- Low bulk heel cup
- Lateral border cut away



Bio-Slimline	Product Code
Bio-Slimline Low Density	BIOFH40(+size)
Bio-Slimline Medium Density	BIOFH60(+size)

Size	XS	S	M	L	XL
Shoe Size (UK)	3 - 4.5	5 - 6.5	7 - 8.5	9 - 10.5	11 - 12.5

LGB Medical Bio-Mex Available direct from Sheffield stock

- Improved biomechanical control
- Polypropylene structure
- Less bulk and better shoe fit for comfort and compliance
- Easily adaptable
- Enhanced durability
- Component kit includes:
 - 2 x 2°, 4° and 6° rearfoot wedges
 - 2 x 5mm heel lifts
 - 2 x heel cushions
 - 2 x full length EVA top covers
- If required, Bio-Mex can be supplied as a 3/4 length shell with a separate self-adhesive full length EVA top cover



Bio-Mex	Product Code
Bio-Mex Low Density - Low Arch	BIOMX10(+size)
Bio-Mex Low Density - Medium Arch	BIOMX20(+size)
Bio-Mex High Density - Low Arch	BIOMX50(+size)
Bio-Mex High Density - Medium Arch	BIOMX60(+size)

Size	XS	S	M	L	XL
Shoe Size (UK)	3 - 4.5	5 - 6.5	7 - 8.5	9 - 10.5	11 - 12.5

LGB Medical Bio-Soft Available direct from Sheffield stock

- Dual density cushioning polyurethane insoles
- Forefoot and calcaneal soft spot to reduce pressure
- Incorporates a wipeable top cover



Bio-Soft	Product Code	Shoe Size (UK)
Bio-Soft Insole Extra Small	BIOSFXS	3 - 4.5
Bio-Soft Insole Small	BIOSFS	5 - 6.5
Bio-Soft Insole Medium	BIOSFM	7 - 8.5
Bio-Soft Insole Large	BIOSFL	9 - 10.5
Bio-Soft Insole Extra Large	BIOSFXL	11 - 12.5

LGB Medical Bio-Soft Plus Available direct from Sheffield stock

- Dual density cushioning polyurethane insoles
- Forefoot and calcaneal soft spot to reduce pressure
- Finished with a memory foam top cover



Bio-Soft Plus	Product Code	Shoe Size (UK)
Bio-Soft Plus Insole Extra Small	BIOSPFXS	3 - 4.5
Bio-Soft Plus Insole Small	BIOSPFS	5 - 6.5
Bio-Soft Plus Insole Medium	BIOSPFM	7 - 8.5
Bio-Soft Plus Insole Large	BIOSPFL	9 - 10.5
Bio-Soft Plus Insole Extra Large	BIOSPFXL	11 - 12.5



How to select TalarMade KinetiX™ Insoles

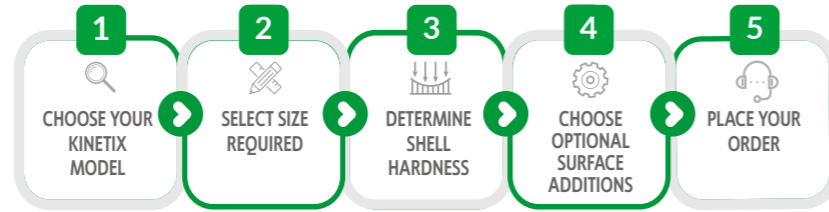

Product Selection by Technical Specification

	KINETIX MODEL				
	A	B	C	D	E
Heel	8° Medial	4° Medial	4° Medial	4° Medial	0
Skive	YES	NO	NO	YES	NO
Forefoot	0	0	Lateral 5°	4° Medial	Lateral 5°
Heel Raise	2mm	0mm	2mm	2mm	2mm

Key:
 Recommended
 Can be used

Paediatric Pathology

	KINETIX MODELS					OPTIONAL SURFACE ADDITIONS					
	A & As	B & Bs	C	D	E	PMP	MET DOME	MET / SULCUS	DANCER PAD	ARCH PAD	HEEL RAISE
Anterior Knee Pain	●	○	○			○					○
Arch Pain	●	○	○			○				○	○
Club Foot / CFEV					●	○					○
Flat / Pronated Foot	○	●	○	○		○				○	○
Freiberg's	○	●	○			○	○	○			○
Hypermobile Pronator	○	○	●		●	○				○	○
Lateral Ankle Instability			○		●	○					○
Low Tone Pronator	●	○	○		●	○				○	○
Low tone Supinator			○		●	○					○
Metatarsalgia	○	●	○		●	○	○	○			○
Metatarsus Adductus					●	○					○
Plantar Heel Pain		○	○		●	○				○	○
Sever's Disease	○	○	○		●	○					○
Shin Splints	●	○	○	○		○					○
Supinated Foot			○		●	○				○	○

Adult Pathology

	KINETIX MODELS					OPTIONAL SURFACE ADDITIONS					
	A & As	B & Bs	C	D	E	PMP	MET DOME	MET / SULCUS	DANCER PAD	ARCH PAD	HEEL RAISE
Achilles Tendonitis	○	●	○			○				○	○
Anterior Knee Pain	●	○	○			○				○	○
Anterior Shin Splints	○	○	○			○				○	○
DMICS	●	○	○		○	○				○	○
Freiberg's	○	●	○			○	○	●	○	○	○
Functional Hallux Limitus	○	●	○		○	○				○	○
Hallux Limitus / Rigidus	●	○	○		○	○				○	○
Hallux Valgus	○	●	○		○	○				○	○
Lateral Ankle Instability			○		●	○				○	○
Medial Knee OA			○		●	○				○	○
Metatarsalgia	○	●	○		○	○	○	○	●	○	○
Midfoot OA	●	○	○			○				○	○
MTSS	○	○		●		○				○	○
Neuroma	○	●	○		○	○	●	○	○	○	○
Peroneal Tendinopathy			○		●	○				○	○
Plantar Fasciopathy	○	○	●		○	○				○	○
Plantar Heel Pain	○	○	○		●	○				○	○
Plantar Plate	○	●	○		○	○	○	●	○	○	○
Sesamoiditis	●	○	○		○	○				○	○
Sinus Tarsi/Lateral Ankle Impingement	●	○	○			○				○	○
Spring Ligament	●	○	○			○				○	○
Tarsal Tunnel Syndrome	○	●	○			○				○	○
Tib Post Dysfunction	●	○	○	●		○				○	○
Trochanteric Bursitis	○	●	○			○				○	○

TalarMade KinetiX™ Model A

- Full length design
- Injection moulded
- Microgrip receptive velour top cover
- Can be used with KinetiX additions
- Supportive heel cup
- 8° Medial heel wedging
- 4mm modified medial heel skive
- Neutrally balanced forefoot
- 5mm finished heel thickness
- 3mm thickness at MTP Joint
- Shore Densities: A40 - Soft, A55 - Medium and A70 - Hard



TalarMade KinetiX™ Model A

Size (UK)	Size (EUR)	A40 Soft Product Code	A55 Medium Product Code	A70 Hard Product Code
C3-3.5	18-19	N/A	KA150	N/A
C4-5	20-21	N/A	KA250	N/A
C6-6.5	22-23	N/A	KA350	N/A
C7-8	24-25	N/A	KA450	N/A
C9-9.5	26-27	N/A	KA550	N/A
C10-11.5	28-29	N/A	KA650	N/A
C12-13	30-31	N/A	KA750	N/A
1-1.5	32-33	N/A	KA850	N/A
2-3	34-35	KA930	KA950	KA970
4-4.5	36-37	KA1030	KA1050	KA1070
5-6	38-39	KA1130	KA1150	KA1170
7-7.5	40-41	KA1230	KA1250	KA1270
8-9.5	42-43	KA1330	KA1350	KA1370
10-11	44-45	KA1430	KA1450	KA1470
11.5-12.5	46-47	KA1530	KA1550	KA1570

TalarMade KinetiX™ Model As

- 3/4 length design
- Injection moulded
- Microgrip receptive velour top cover
- Can be used with KinetiX additions
- Supportive heel cup
- 8° Medial heel wedging
- High medial arch profile
- Plantar flexed 1st ray in shell
- 4mm modified medial heel skive
- 5mm finished heel thickness
- Shore Densities: A40 - Soft, A55 - Medium and A70 - Hard



TalarMade KinetiX™ Model As

Size (UK)	Size (EUR)	A40 Soft Product Code	A55 Medium Product Code	A70 Hard Product Code
2-3	34-35	KAS930	KAS950	KAS970
4-4.5	36-37	KAS1030	KAS1050	KAS1070
5-6	38-39	KAS1130	KAS1150	KAS1170
7-7.5	40-41	KAS1230	KAS1250	KAS1270
8-9.5	42-43	KAS1330	KAS1350	KAS1370
10-11	44-45	KAS1430	KAS1450	KAS1470
11.5-12.5	46-47	KAS1530	KAS1550	KAS1570

TalarMade KinetiX™ Model B

- Full length design
- Injection moulded
- Microgrip receptive velour top cover
- Can be used with KinetiX additions
- Supportive heel cup
- High medial arch profile
- 4° Medial heel wedge
- Plantarflexed 1st ray in shell
- Neutrally balanced forefoot
- 3mm finished heel thickness
- 3mm thickness at MTP Joint
- Shore Densities: A40 - Soft, A55 - Medium and A70 - Hard



TalarMade KinetiX™ Model B

Size (UK)	Size (EUR)	A40 Soft Product Code	A55 Medium Product Code	A70 Hard Product Code
C3-3.5	18-19	N/A	KB150	N/A
C4-5	20-21	N/A	KB250	N/A
C6-6.5	22-23	N/A	KB350	N/A
C7-8	24-25	N/A	KB450	N/A
C9-9.5	26-27	N/A	KB550	N/A
C10-11.5	28-29	N/A	KB650	N/A
C12-13	30-31	N/A	KB750	N/A
1-1.5	32-33	N/A	KB850	N/A
2-3	34-35	KB930	KB950	KB970
4-4.5	36-37	KB1030	KB1050	KB1070
5-6	38-39	KB1130	KB1150	KB1170
7-7.5	40-41	KB1230	KB1250	KB1270
8-9.5	42-43	KB1330	KB1350	KB1370
10-11	44-45	KB1430	KB1450	KB1470
11.5-12.5	46-47	KB1530	KB1550	KB1570

TalarMade KinetiX™ Model C

- Full length design
- Injection moulded
- Microgrip receptive velour top cover
- Can be used with KinetiX additions
- 4° medial heel wedge
- 5° lateral forefoot wedge
- Anatomically shaped medial arch profile
- Plantarflexed 1st ray in shell
- 5mm finished heel thickness
- 3mm thickness at MTP Joint
- Shore Densities: A40 - Soft, A55 - Medium and A70 - Hard



TalarMade KinetiX™ Model C

Size (UK)	Size (EUR)	A40 Soft Product Code	A55 Medium Product Code	A70 Hard Product Code
C3-3.5	18-19	N/A	N/A	N/A
C4-5	20-21	N/A	N/A	N/A
C6-6.5	22-23	N/A	N/A	N/A
C7-8	24-25	N/A	N/A	N/A
C9-9.5	26-27	N/A	N/A	N/A
C10-11.5	28-29	N/A	N/A	N/A
C12-13	30-31	N/A	N/A	N/A
1-1.5	32-33	N/A	N/A	N/A
2-3	34-35	KC930	KC950	KC970
4-4.5	36-37	KC1030	KC1050	KC1070
5-6	38-39	KC1130	KC1150	KC1170
7-7.5	40-41	KC1230	KC1250	KC1270
8-9.5	42-43	KC1330	KC1350	KC1370
10-11	44-45	KC1430	KC1450	KC1470
11.5-12.5	46-47	KC1530	KC1550	KC1570

TalarMade KinetiX™ Model Bs

- 3/4 length design
- Injection moulded
- Microgrip receptive velour top cover
- Can be used with KinetiX additions
- Supportive heel cup
- High medial arch profile
- 4° Medial heel wedge
- Plantarflexed 1st ray in shell
- 3mm finished heel thickness
- Shore Densities: A40 - Soft, A55 - Medium and A70 - Hard



TalarMade KinetiX™ Model Bs

Size (UK)	Size (EUR)	A40 Soft Product Code	A55 Medium Product Code	A70 Hard Product Code
2-3	34-35	KBS930	KBS950	KBS970
4-4.5	36-37	KBS1030	KBS1050	KBS1070
5-6	38-39	KBS1130	KBS1150	KBS1170
7-7.5	40-41	KBS1230	KBS1250	KBS1270
8-9.5	42-43	KBS1330	KBS1350	KBS1370
10-11	44-45	KBS1430	KBS1450	KBS1470
11.5-12.5	46-47	KBS1530	KBS1550	KBS1570

TalarMade KinetiX™ Model D

- Full length design
- Injection moulded
- Microgrip receptive velour top cover
- Can be used with KinetiX additions
- 4° Medial Heel Wedge
- 4mm modified medial heel skive
- 5° medial forefoot wedge
- 5mm finished heel thickness
- Shore Densities: A40 - Soft, A55 - Medium and A70 - Hard



TalarMade KinetiX™ Model D

Size (UK)	Size (EUR)	A40 Soft Product Code	A55 Medium Product Code	A70 Hard Product Code
2-3	34-35	KD930	KD950	KD970
4-4.5	36-37	KD1030	KD1050	KD1070
5-6	38-39	KD1130	KD1150	KD1170
7-7.5	40-41	KD1230	KD1250	KD1270
8-9.5	42-43	KD1330	KD1350	KD1370
10-11	44-45	KD1430	KD1450	KD1470
11.5-12.5	46-47	KD1530	KD1550	KD1570

TalarMade KinetiX™ Model E

- Full length design
- Injection moulded
- Microgrip receptive velour top cover
- Can be used with KinetiX additions
- SLower medial arch profile
- Raised lateral arch height
- Neutral heel post
- 5° lateral forefoot wedging
- Plantarflexed 1st ray in shell
- 5mm finished heel thickness
- Shore Densities: A40 - Soft, A55 - Medium and A70 - Hard



TalarMade KinetiX™ Model E

Size (UK)	Size (EUR)	A40 Soft Product Code	A55 Medium Product Code	A70 Hard Product Code
C3-3.5	18-19	N/A	KE150	N/A
C4-5	20-21	N/A	KE250	N/A
C6-6.5	22-23	N/A	KE350	N/A
C7-8	24-25	N/A	KE450	N/A
C9-9.5	26-27	N/A	KE550	N/A
C10-11.5	28-29	N/A	KE650	N/A
C12-13	30-31	KE730	KE750	KE770
1-1.5	32-33	KE830	KE850	KE870
2-3	34-35	KE930	KE950	KE970
4-4.5	36-37	KE1030	KE1050	KE1070
5-6	38-39	KE1130	KE1150	KE1170
7-7.5	40-41	KE1230	KE1250	KE1270
8-9.5	42-43	KE1330	KE1350	KE1370
10-11	44-45	KE1430	KE1450	KE1470
11.5-12.5	46-47	KE1530	KE1550	KE1570

PMP Pads

TalarMade KinetiX™ PMP Pads

Size	Dimensions	Qty	Product Code
Small	125 x 65 x 3mm	Pair	PMP-PU/MG/S/P
Small	125 x 65 x 3mm	Pack of 5	PMP-PU/MG/S/P5
Large	150 x 70 x 3mm	Pair	PMP-PU/MG/L/P
Large	150 x 70 x 3mm	Pack of 5	PMP-PU/MG/L/P5

Arch Pads

TalarMade KinetiX™ Arch Pads

Size	Dimensions	Qty	Product Code
Small	90 x 40 x 8mm	Pair	ARCH-EVA/MG/S/P
Small	90 x 40 x 8mm	Pack of 5	ARCH-EVA/MG/S/P5
Medium	110 x 47 x 8mm	Pair	ARCH-EVA/MG/M/P
Medium	110 x 47 x 8mm	Pack of 5	ARCH-EVA/MG/M/P5
Large	118 x 52 x 8mm	Pair	ARCH-EVA/MG/L/P
Large	118 x 52 x 8mm	Pack of 5	ARCH-EVA/MG/L/P5

Teardrop Metatarsal Domes

TalarMade KinetiX™ Teardrop Metatarsal Domes

Size	Dimensions	Qty	Product Code
1	44 x 32 x 7mm	Pair	TMET-EVA/MG/S1/P
1	44 x 32 x 7mm	Pack of 5	TMET-EVA/MG/S1/P5
3	49 x 43 x 7mm	Pair	TMET-EVA/MG/S3/P
3	49 x 43 x 7mm	Pack of 5	TMET-EVA/MG/S3/P5
5	64 x 54 x 7mm	Pair	TMET-EVA/MG/S5/P
5	64 x 54 x 7mm	Pack of 5	TMET-EVA/MG/S5/P5

Metatarsal Domes

TalarMade KinetiX™ Metatarsal Domes

Size	Dimensions	Qty	Product Code
1	44 x 32 x 7	Pair	TMET-EVA/MG/S1/P
1	44 x 32 x 7	Pack of 5	TMET-EVA/MG/S1/P5
3	49 x 43 x 7	Pair	TMET-EVA/MG/S3/P
3	49 x 43 x 7	Pack of 5	TMET-EVA/MG/S3/P5
5	64 x 54 x 7	Pair	TMET-EVA/MG/S5/P
5	64 x 54 x 7	Pack of 5	TMET-EVA/MG/S5/P5

Metatarsal/Sulcus Pads

TalarMade KinetiX™ Metatarsal/Sulcus Pads

Size	Dimensions	Qty	Product Code
Small	70 x 60 x 7mm	Pair	METSUL-EVA/MG/S/P
Small	70 x 60 x 7mm	Pack of 5	METSUL-EVA/MG/S/P5
Large	77 x 68 x 9mm	Pair	METSUL-EVA/MG/L/P
Large	77 x 68 x 9mm	Pack of 5	METSUL-EVA/MG/L/P5

Dancer Pads

TalarMade KinetiX™ Dancer Pads

Size	Dimensions	Qty	Product Code
Small	80 x 60 x 7mm	Pair	DMET-EVA/MG/S/P
Small	80 x 60 x 7mm	Pack of 5	DMET-EVA/MG/S/P5
Large	80 x 65 x 7mm	Pair	DMET-EVA/MG/L/P
Large	80 x 65 x 7mm	Pack of 5	DMET-EVA/MG/L/P5

TalarMade KinetiX™ Additions Microgrip Surface Addition Selction Chart

KINETIX ADDITIONS						
PMP Pads	Arch Pads	Teardrop Metatarsal Domes	Metatarsal Domes	Metatarsal Sulcus Pads	Dancer Pads	Heel Raises
Impact: Reduces 1st MTH load	Impact: Increase arch height	Impact: Reduces site metatarsal head load / pressure	Impact: Reduces metatarsal head load/pressure	Impact: Once trimmed, offloads plantar plate / metatarsal head	Impact: Reduces forefoot loads on MTH's 2-5 (metatarsal bar)	Impact: Increase heel height of Orthosis
Recommended For: Sesamoiditis Functional Hallux Limitus Lateral Ankle Instability Peroneal Tendinopathy Plantar fasciopathy	Recommended For: High Arched Feet Increased forces under medial or lateral arches	Recommended For: Morton's Neuroma	Recommended For: Plantar Forefoot pain	Recommended For: Plantar Plate Dysfunction Offloading Corns Freiberg's	Recommended For: Plantar Forefoot Pain Retracted 2-5 Toes	Recommended For: Reducing Plantarflexion Tension Achilles Tendinopathy Tension Leg Length Correction Orthosis Turning

Heel Raises - Adhesive Backed Only

TalarMade KinetiX™ Heel Raises - Adhesive Backed Only

Size	Dimensions	Qty	Product Code	Qty	Product Code
Small	4mm	1	FMB-HDHE/4S/P	10	FMB-HDHE/4S
Medium	4mm	1	FMB-HDHE/4M/P	10	FMB-HDHE/4M
Large	4mm	1	FMB-HDHE/4L/P	10	FMB-HDHE/4L
Small	6mm	1	FMB-HDHE/6S/P	10	FMB-HDHE/6S
Medium	6mm	1	FMB-HDHE/6M/P	10	FMB-HDHE/6M
Large	6mm	1	FMB-HDHE/6L/P	10	FMB-HDHE/6L
Small	8mm	1	FMB-HDHE/8S/P	10	FMB-HDHE/8S
Medium	8mm	1	FMB-HDHE/8M/P	10	FMB-HDHE/8M
Large	8mm	1	FMB-HDHE/8L/P	10	FMB-HDHE/8L
Small	10mm	1	FMB-HDHE/10S/P	10	FMB-HDHE/10S
Medium	10mm	1	FMB-HDHE/10M/P	10	FMB-HDHE/10M
Large	10mm	1	FMB-HDHE/10L/P	10	FMB-HDHE/10L
Small	12mm	1	FMB-HDHE/12S/P	10	FMB-HDHE/12S
Medium	12mm	1	FMB-HDHE/12M/P	10	FMB-HDHE/12M
Large	12mm	1	FMB-HDHE/12L/P	10	FMB-HDHE/12L
Small	15mm	1	FMB-HDHE/15S/P	10	FMB-HDHE/15S
Medium	15mm	1	FMB-HDHE/15M/P	10	FMB-HDHE/15M
Large	15mm	1	FMB-HDHE/15L/P	10	FMB-HDHE/15L

TalarMade Prostep™ Insoles

- Sustentaculum Tali modification to generate increased moments relative to the STJ axis
- Suitable for treating patients with a medially deviated STJ axis
- EVA shell in 2 densities
- Available in 3/4 and full length
- Medial heel post options, 0°, 3° and 5° degrees included
- Microfibre top cover
- Can be used in conjunction with TalarMade MicroGrip surface additions

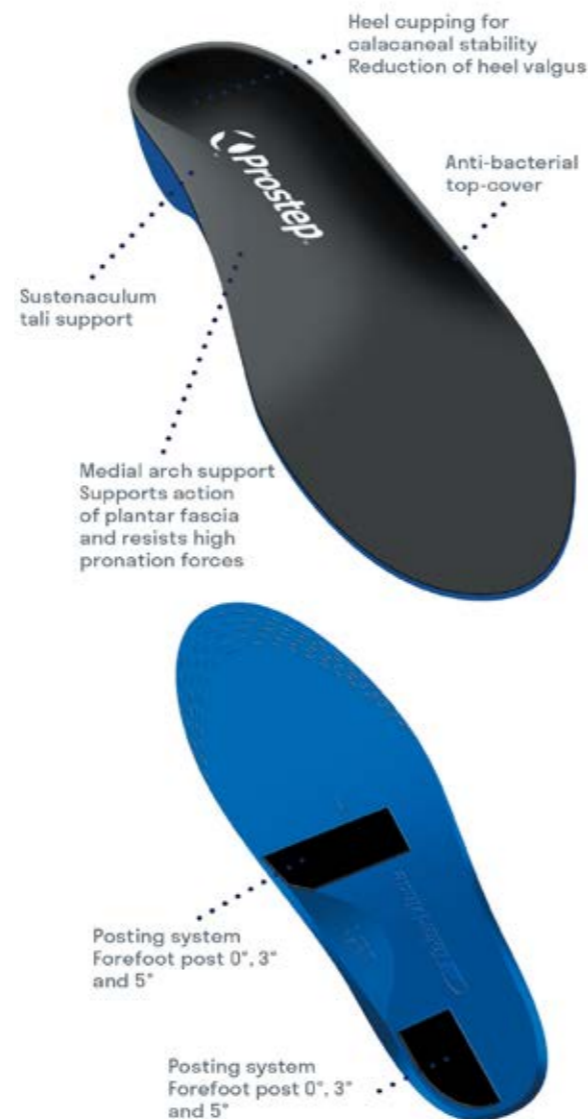

TalarMade Prostep™ 3/4 Length (Pair)

Size	Medium Density Product Code	Firm Density Product Code	Size (UK)	Size (EUR)
Kids Small	PSSLMKS	PSSLFKS	13.5 - 1.5	32 - 33
Kids Large	PSSLMKL	PSSLFKL	2 - 3	34 - 35
Extra Small	PSSLMXS	PSSLFXS	3.5 - 4.5	36 - 37
Small	PSSLMS	PSSLFS	5 - 6	38 - 39
Medium	PSSLMM	PSSLFL	6.5 - 7.5	40 - 41
Large	PSSLML	PSSLFL	8 - 9	42 - 43
Extra Large	PSSLMXL	PSSLFXL	9.5 - 10.5	44 - 45
Extra Extra Large	PSSLMXXL	PSSLFXXL	11 - 12	46 - 47

TalarMade Prostep™ Full Length (Pair)

Size	Medium Density Product Code	Firm Density Product Code	Size (UK)	Size (EUR)
Kids Small	PSFLMKS	PSFLFKS	13.5 - 1.5	32 - 33
Kids Large	PSFLMKL	PSFLFKL	2 - 3	34 - 35
Extra Small	PSFLMXS	PSFLFXS	3.5 - 4.5	36 - 37
Small	PSFLMS	PSFLFS	5 - 6	38 - 39
Medium	PSFLMM	PSFLFM	6.5 - 7.5	40 - 41
Large	PSFLML	PSFLFL	8 - 9	42 - 43
Extra Large	PSFLMXL	PSFLFXL	9.5 - 10.5	44 - 45
Extra Extra Large	PSFLMXXL	PSFLFXXL	11 - 12	46 - 47

TalarMade A30 EVA Met Pads

- Teardrop shaped metatarsal domes
- Can be used as Neuroma and cuboid/Feheery pads
- Available in EVA with MicroGrip and PU Gel with self-adhesive
- Compatible with all TalarMade foot orthoses and Pedro PRO footwear



TalarMade A30 EVA Met Pads (5 pairs per pack)

Size	Product Code
Small	MET-EVA/MG/S/P5
Medium	MET-EVA/MG/M/P5
Large	MET-EVA/MG/L/P5

TalarMade Elite Insoles

- SEVA construction
- Available in 3 densities; Soft 30 shore, Medium 45 shore and Firm 60 shore
- Intrinsic neutral medial heel post
- Mild metatarsal support
- Robust heel cup
- Antimicrobial top cover
- Replaceable heel and 1st MTH cushioning
- Plantar surface can be easily customised using MicroGrip surface additions
- Multiple extrinsic wedge options for further customisation
- Available in both 3/4 and full length



TalarMade Elite Insoles - 3/4 Length (Pair)

Size	Soft 30 SHORE Product Code	Medium 45 SHORE Product Code	Firm 60 SHORE Product Code	Size (UK)	Size (EUR)
Extra Small	ELTSL/S/XS	ELTSL/M/XS	ELTSL/F/XS	3 - 4.5	35 - 37
Small	ELTSL/S/S	ELTSL/M/S	ELTSL/F/S	5 - 6.5	38 - 40
Medium	ELTSL/S/M	ELTSL/M/M	ELTSL/F/M	7 - 8.5	40.5 - 42.5
Large	ELTSL/S/L	ELTSL/M/L	ELTSL/F/L	9 - 10.5	43 - 45
Extra Large	ELTSL/S/XL	ELTSL/M/XL	ELTSL/F/XL	11 - 12.5	46 - 48

TalarMade Elite Insoles - Full Length (Pair)

Size	Soft 30 SHORE Product Code	Medium 45 SHORE Product Code	Firm 60 SHORE Product Code	Size (UK)	Size (EUR)
Extra Small	ELTFL/S/XS	ELTFL/M/XS	ELTFL/F/XS	3 - 4.5	35 - 37
Small	ELTFL/S/S	ELTFL/M/S	ELTFL/F/S	5 - 6.5	38 - 40
Medium	ELTFL/S/M	ELTFL/M/M	ELTFL/F/M	7 - 8.5	40.5 - 42.5
Large	ELTFL/S/L	ELTFL/M/L	ELTFL/F/L	9 - 10.5	43 - 45
Extra Large	ELTFL/S/XL	ELTFL/M/XL	ELTFL/F/XL	11 - 12.5	46 - 48

TalarMade Equiflex Insole

- Heel cupping for calcaneal stability and reduction of heel valgus
- Anti-bacterial top cover
- Medial arch support
- Supplied with 0°, 3° and 5° medial and lateral forefoot posts
- Supports actions of plantar fascia
- Resists high pronation forces
- 1st metatarsal head recess
- Contoured for equinus and lateral loading correction - the Equiflex foot orthosis is contoured to improve the ability of the high arch foot to function correctly



TalarMade Equiflex Insoles - Full Length (Pair)

Size	Medium Density Product Code	Firm Density Product Code	Size (UK)	Size (EUR)
Extra Small	EQMXS	EQFXS	3.5 - 4.5	36 - 37
Small	EQMS	EQFS	5 - 6	38 - 39
Medium	EQMM	EQFM	6.5 - 7.5	40 - 41
Large	EQML	EQFL	8 - 9	42 - 43
Extra Large	EQMXL	EQFXL	9.5 - 10.5	44 - 45
Extra Extra Large	EQMXXL	EQFXXL	11 - 12	46 - 47

TalarMade Trio Easy Fit™ Insoles

- Designed to fit in dress/fashion shoes
- Provides excellent talo-navicular and arch support
- Intrinsic 4° medial heel wedge
- Intrinsic 1st MTH cushioning
- Available in 3/4 length medium density EVA
- Microfibre top cover
- Can be used in conjunction with TalarMade MicroGrip surface additions

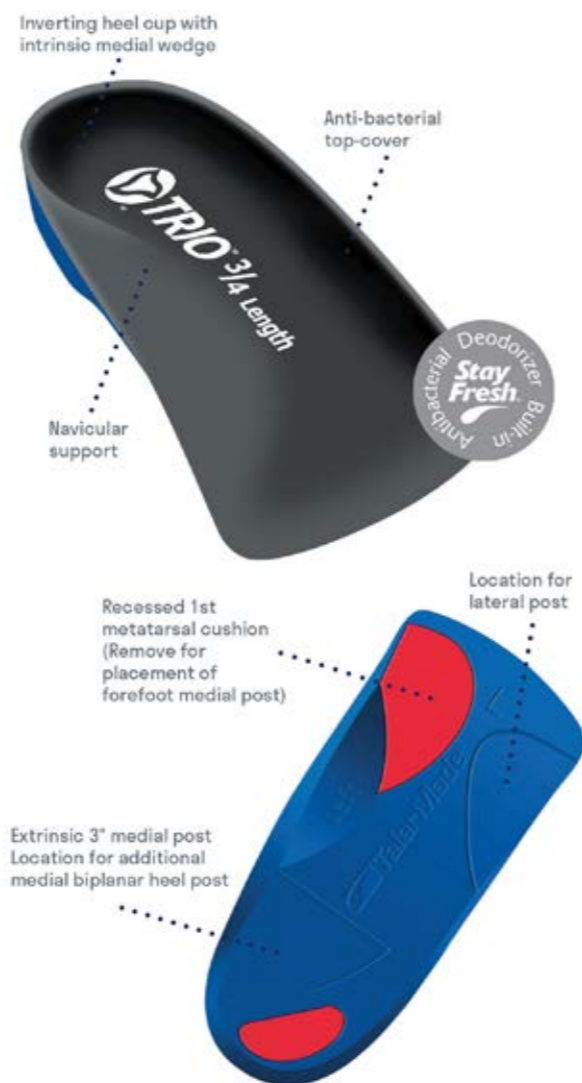

TalarMade Trio Easy Fit™ Insoles

Size	Product Code	Size (UK)	Size (EUR)
Kids	TEFK	1 - 2	32.5 - 34.5
Extra Small	TEFXS	3 - 4.5	35 - 37
Small	TEFS	5 - 6.5	38 - 40
Medium	TEFM	7 - 8.5	40.5 - 42.5
Large	TEFL	9 - 10.5	43 - 45
Extra Large	TEFXL	11 - 12.5	46 - 48

TalarMade 1st Line™ Insoles

- Heat mouldable shell
- Deep moulded heel cups
- Gentle supportive arch structure
- Stable base
- 3 choices of density
- Available in full and 3/4 lengths
- 3° and 5° adhesive backed medial posts
- Can be used with self-adhesive TalarMade surface additions



TalarMade 1st Line™ Insoles - 3/4 Length

Size	Soft Density Product Code	Medium Density Product Code	Firm Density Product Code	Size (UK)	Size (EUR)
Extra Small	1LSLSXS	1LSLMXS	1LSLFXS	3 - 4.5	35 - 37
Small	1LSLSS	1LSLMS	1LSLFS	5 - 6	38 - 39
Medium	1LSLSM	1LSLMM	1LSLFM	6.5 - 7.5	40 - 41
Large	1LSLSL	1LSLML	1LSLFL	8 - 9	42 - 43
Extra Large	1LSLSXL	1LSLMXL	1LSLFXL	9.5 - 10.5	44 - 45
Extra Extra Large	1LSLSXXL	1LSLMXXL	1LSLFXXL	11 - 12	46 - 47

TalarMade 1st Line™ Insoles - Full Length

Size	Soft Density Product Code	Medium Density Product Code	Firm Density Product Code	Size (UK)	Size (EUR)
Extra Small	1LFLSXS	1LFLMXS	1LFLFXS	3 - 4.5	35 - 37
Small	1LFLSS	1LFLMS	1LFLFS	5 - 6	38 - 39
Medium	1LFLSM	1LFLMM	1LFLFM	6.5 - 7.5	40 - 41
Large	1LFLSL	1LFLML	1LFLFL	8 - 9	42 - 43
Extra Large	1LFLSXL	1LFLMXL	1LFLFXL	9.5 - 10.5	44 - 45
Extra Extra Large	1LFLSXXL	1LFLMXXL	1LFLFXXL	11 - 12	46 - 47

TalarMade Gaitway™ Slim Insoles

- Low profile for easy accommodation in slip-on fashion footwear
- Cost effective, functional foot orthosis for the pronating foot
- Shore A50 for consistent control and increased durability
- Arch shape allows for improved 1st Ray function
- Microfibre top cover for increased comfort
- Medial heel post options - 0°, 3° & 5° included
- 3 style options
- Can be used in conjunction with TalarMade MicroGrip surface additions



TalarMade Gaitway™ Slim Insoles

Size	Product Code	Size (UK)	Size (EUR)
Small	GWS/S	3 - 5	36 - 38
Medium	GWS/M	5 - 7	39 - 41
Large	GWS/L	8 - 11	42 - 45

Schein NovaPED Carbon Hallux Rigidus Long Spring

- For the treatment of Hallux Rigidus to reduce pressure exerted on the joint to aid correct gait and reduce pain
- **Only selected Schein insoles are stocked in the UK, see individual products for reference**

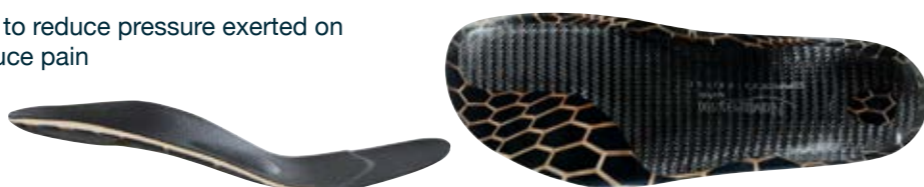

Available direct from Sheffield stock

Size (EU)	NovaPED Carbon Hallux Rigidus Long Spring (Firm) Narrow - Left	NovaPED Carbon Hallux Rigidus Long Spring (Firm) Narrow - Right	NovaPED Carbon Hallux Rigidus Long Spring (Firm) Wide - Left	NovaPED Carbon Hallux Rigidus Long Spring (Firm) Wide - Right
	Product Code	Product Code	Product Code	Product Code
35	983221-000-35	983121-000-35	983231-000-35	983131-000-35
36	983221-000-36	983121-000-36	983231-000-36	983131-000-36
37	983221-000-37	983121-000-37	983231-000-37	983131-000-37
38	983221-000-38	983121-000-38	983231-000-38	983131-000-38
39	983221-000-39	983121-000-39	983231-000-39	983131-000-39
40	983221-000-40	983121-000-40	983231-000-40	983131-000-40
41	983221-000-41	983121-000-41	983231-000-41	983131-000-41
42	983221-000-42	983121-000-42	983231-000-42	983131-000-42
43	983221-000-43	983121-000-43	983231-000-43	983131-000-43
44	983221-000-44	983121-000-44	983231-000-44	983131-000-44
45	983221-000-45	983121-000-45	983231-000-45	983131-000-45
46	983221-000-46	983121-000-46	983231-000-46	983131-000-46
47	983221-000-47	983121-000-47	983231-000-47	983131-000-47
48	983221-000-48	983121-000-48	983231-000-48	983131-000-48

Schein NovaPED Carbon Compensation Insoles

- Compensation insole to be used in conjunction with Hallux carbon insoles for unilateral treatment
- **Only selected Schein insoles are stocked in the UK, see individual products for reference**

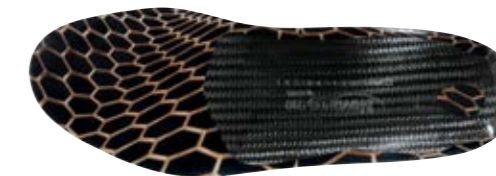

Available direct from Sheffield stock

Size (EU)	NovaPED Compensation Insoles (Firm) Narrow - Left	NovaPED Compensation Insoles (Firm) Narrow - Right	NovaPED Compensation Insoles (Firm) Wide - Left	NovaPED Compensation Insoles (Firm) Wide - Right
	Product Code	Product Code	Product Code	Product Code
35	983241-000-35	983141-000-35	983246-000-35	983146-000-35
36	983241-000-36	983141-000-36	983246-000-36	983146-000-36
37	983241-000-37	983141-000-37	983246-000-37	983146-000-37
38	983241-000-38	983141-000-38	983246-000-38	983146-000-38
39	983241-000-39	983141-000-39	983246-000-39	983146-000-39
40	983241-000-40	983141-000-40	983246-000-40	983146-000-40
41	983241-000-41	983141-000-41	983246-000-41	983146-000-41
42	983241-000-42	983141-000-42	983246-000-42	983146-000-42
43	983241-000-43	983141-000-43	983246-000-43	983146-000-43
44	983241-000-44	983141-000-44	983246-000-44	983146-000-44
45	983241-000-45	983141-000-45	983246-000-45	983146-000-45
46	983241-000-46	983141-000-46	983246-000-46	983146-000-46
47	983241-000-47	983141-000-47	983246-000-47	983146-000-47
48	983241-000-48	983141-000-48	983246-000-48	983146-000-48

Algeos Interpod Insole Range

- Thin, light, slim fit for comfort in all shoes
- Available in 3 arch heights
- Self-adhesive, full length top cover and 3/4 length cover included in the pack as standard:
 - High quality 3mm EVA used
 - Quick return foam base
 - Removable first ray addition (full length only)
 - Easy to adhere additions

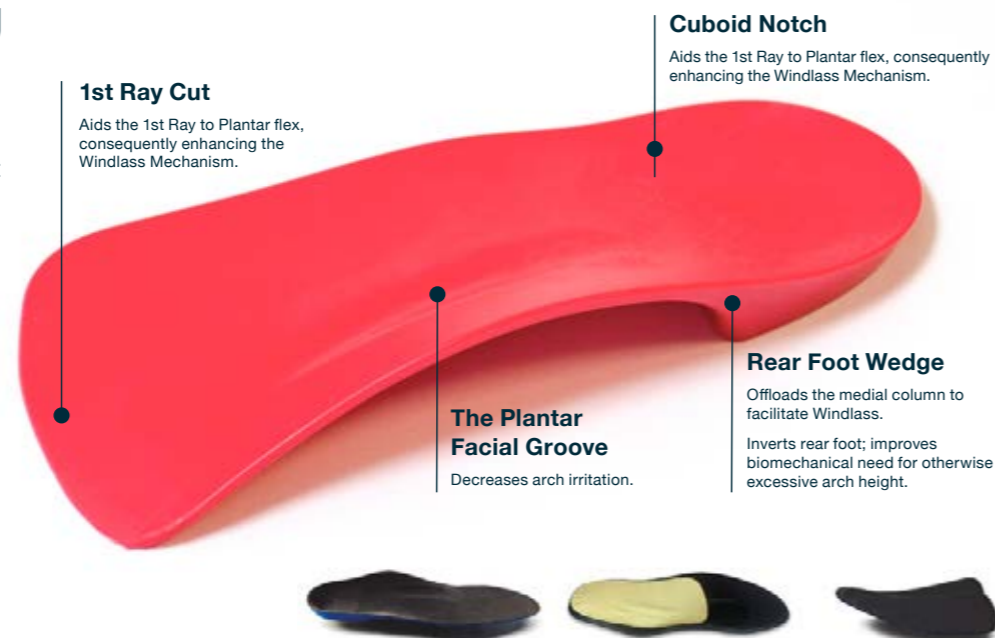

Algeos Interpod Flex 3/4 Length 4° Insole

- Eliminates pronation moments about the subtalar joint created by the lateral heel cup
- Lightweight and easy fitting
- Cuboid notch
- Plantar fascial groove reduces arch irritation
- Made from durable polypropylene
- Heat mouldable



Algeos Interpod Flex 3/4 Length 4° Insole	Size (UK)
SC3021	3 - 4
SC3022	5 - 6
SC3023	7 - 8
SC3024	9 - 10
SC3025	11 - 12

Algeos Interpod Flex 3/4 Length 6° Insole

- Eliminates pronation moments about the subtalar joint created by the lateral heel cup
- Lightweight and easy fitting
- Cuboid notch
- Plantar fascial groove reduces arch irritation
- Made from durable polypropylene
- Heat mouldable



Algeos Interpod Flex 3/4 Length 6° Insole	Size (UK)
SC3011	3 - 4
SC3012	5 - 6
SC3013	7 - 8
SC3014	9 - 10
SC3015	11 - 12
SC3016	13 - 15

Algeos Interpod Flex 3/4 Length 8° Insole

- Eliminates pronation moments about the subtalar joint created by the lateral heel cup
- Lightweight and easy fitting
- Cuboid notch
- Plantar fascial groove reduces arch irritation
- Made from durable polypropylene
- Heat mouldable

Algeos Interpod Flex 3/4 Length 8° Insole	Size (UK)
SC3001	3 - 4
SC3002	5 - 6
SC3003	7 - 8
SC3004	9 - 10
SC3005	11 - 12



Algeos Interpod Soft 3/4 Length 6° Insole

- Rearfoot wedging reduces the need for excessive arch height, while maintaining support, comfort and superior shock absorption
- Lightweight and easy fitting
- Cuboid notch
- Plantar fascial groove reduces arch irritation
- Moisture diffusion
- Ideal in assisting those with bony prominences



Algeos Interpod Soft 3/4 Length 6° Insole	Size (UK)
SC3055	2 - 3
SC3056	3 - 4
SC3057	5 - 6
SC3058	7 - 8
SC3059	9 - 10
SC3060	11 - 12

Algeos Interpod Soft 6° Moderate Arch Full Length Insole

- Rearfoot wedging reduces the need for excessive arch height, while maintaining support, comfort and superior shock absorption
- Lightweight and easy fitting
- Cuboid notch
- Plantar fascial groove reduces arch irritation
- Moisture diffusion
- Ideal in assisting those with bony prominences



Algeos Interpod Soft 6° Moderate Arch Full Length Insole	Size (UK)
SC3086	Child UK 10-12
SC3088	Child UK 1-2
SC3040	2.5 - 3.5
SC3041	3 - 4
SC3042	5 - 6
SC3043	7 - 8
SC3044	9 - 10
SC3045	11 - 12
SC3046	13 - 15

Algeos Interpod Soft 4° Low Arch Full Length Insole

- Rearfoot wedging reduces the need for excessive arch height, while maintaining support, comfort and superior shock absorption
- Lightweight and easy fitting
- Cuboid notch
- Plantar fascial groove reduces arch irritation
- Moisture diffusion
- Ideal in assisting those with bony prominences



Algeos Interpod Soft 4° Low Arch Full Length Insole

Algeos Interpod Soft 4° Low Arch Full Length Insole	Size (UK)
SC3090	2 - 3
SC3091	3 - 4
SC3092	5 - 6
SC3093	7 - 8
SC3094	9 - 10
SC3095	11 - 12
SC3096	13 - 14

Algeos Interpod Soft 8° Arch Full Length Insole

- Rearfoot wedging reduces the need for excessive arch height, while maintaining support, comfort and superior shock absorption
- Lightweight and easy fitting
- Cuboid notch
- Plantar fascial groove reduces arch irritation
- Moisture diffusion
- Ideal in assisting those with bony prominences



Algeos Interpod Soft 8° Arch Full Length Insole

Algeos Interpod Soft 8° Arch Full Length Insole	Size (UK)
SC3031	3 - 4
SC3032	5 - 6
SC3033	7 - 8
SC3034	9 - 10

Algeos Memopur Softee Insoles

- Standard 18mm heel cup and 28mm valgus height
- Tapered to 5mm and 3mm forefoot
- Heat mouldable at 150°C
- Machine washable up to 40°C



Algeos Memopur Softee Insoles

Algeos Memopur Softee Insoles	Size (UK)
SB4630	2 - 3
SB4632	4 - 5
SB4634	5.5 - 6
SB4636	7 - 8
SB4638	9 - 9.5
SB4640	10 - 11
SB4642	11.5 - 12

Algeos Interpod Soft 0° Low Stiffness Full Length Insole

- Increased comfort
- Lightweight
- Added support under the heel and arch fills for comfort and cushioning
- Neutral position can be increased with additions
- Slimmer fitting improved shoe fit options
- Open-cell foam mid-layer increases moisture wicking with anti-microbial properties



Algeos Interpod Soft 0° Low Stiffness Full Length Insole

Algeos Interpod Soft 0° Low Stiffness Full Length Insole	Size (UK)
SC3839	3 - 4
SC3840	5 - 6
SC3841	7 - 8
SC3842	9 - 10
SC3843	11 - 12

Algeos Interpod Soft 0° High Stiffness Full Length Insole

- Increased comfort
- Lightweight
- Added support under the heel and arch fills for comfort and cushioning
- Neutral position can be increased with additions
- Slimmer fitting improved shoe fit options
- Open-cell foam mid-layer increases moisture wicking with anti-microbial properties



Algeos Interpod Soft 0° High Stiffness Full Length Insole

Algeos Interpod Soft 0° High Stiffness Full Length Insole	Size (UK)
SC3834	3 - 4
SC3835	5 - 6
SC3836	7 - 8
SC3837	9 - 10
SC3838	11 - 12

Algeos Memopur Control Insoles

- Standard 18mm heel cup and 28mm valgus height
- Tapered to 5mm and 3mm forefoot
- Heat mouldable at 150°C
- Machine washable up to 40°C



Algeos Memopur Control Insoles

Algeos Memopur Control Insoles	Size (UK)
SB4644	2 - 3
SB4646	4 - 5
SB4648	5.5 - 6
SB4650	7 - 8
SB4652	9 - 9.5
SB4654	10 - 11
SB4656	11.5 - 12

Algeos Memopur Control Split Insoles

- Standard 18mm heel cup and 28mm valgus height
- Tapered to 5mm and 3mm forefoot
- Heat mouldable at 150°C
- Machine washable up to 40°C



Algeos Memopur Control Split Insoles	Size (UK)
SB4658	2 - 3
SB4660	4 - 5
SB4662	5.5 - 6
SB4664	7 - 8
SB4666	9 - 9.5
SB4668	10 - 11
SB4670	11.5 - 12

Algeos Memopur Control Plus Insoles

- Standard 18mm heel cup and 28mm valgus height
- Tapered to 5mm and 3mm forefoot
- Heat mouldable at 150°C
- Machine washable up to 40°C



Algeos Memopur Control Plus Insoles	Size (UK)
SB4672	2 - 3
SB4674	4 - 5
SB4676	5.5 - 6
SB4678	7 - 8
SB4680	9 - 9.5
SB4682	10 - 11

Algeos Slimflex Comfort Insole

- Available in high, medium and low density
- Heat mouldable and grindable allowing for quick modification and patient customisation
- Flat base allows for all posting types
- Brush nylon cover allows for comfort and moisture absorption
- Integrated first metatarsal cut-out to facilitate the windlass mechanism
- Metatarsal raise and sustentaculum tali support
- Deep heel cup for greater control

Slimflex Comfort Insole High Density	Slimflex Comfort Insole Medium Density	Slimflex Comfort Insole Low Density	Size (UK)	Size (EUR)
SB5050	SB4100	SB6098	12 - 13.5	30 - 32
SB5052	SB4102	SB6100	1 - 2.5	33 - 35
SB5054	SB4104	SB6102	3 - 4.5	36 - 38
SB5056	SB4106	SB6104	5 - 6.5	39 - 40
SB5058	SB4108	SB6106	7 - 8.5	41 - 42
SB5060	SB4110	SB6108	9 - 10.5	43 - 44
SB5062	SB4112	SB6110	11 - 12.5	45 - 48
SB5064	SB4114	SB6112	13 - 14.5	49 - 51

Slimflex Insole High Density



Slimflex Insole Medium Density



Slimflex Insole Medium Density



Algeos Slimflex Simple Insole

- Available in high and medium density
- Heat mouldable and grindable, allows for quick modification
- Can be customised with addition pack

Slimflex Simple Insole High Density	Slimflex Simple Insole Medium Density	Size (UK)	Size (EUR)
SB3102	SB2557	12 - 13.5	30 - 32
SB3104	SB2559	1 - 2.5	33 - 35
SB3106	SB2561	3 - 4.5	36 - 38
SB3108	SB2563	5 - 6.5	39 - 40
SB3110	SB2565	7 - 8.5	41 - 42
SB3112	SB2567	9 - 10.5	43 - 44
SB3114	SB2569	11 - 12.5	45 - 48
SB3116	SB2571	13 - 14.5	49 - 51

Slimflex Simple Insole High Density



High density available direct from Sheffield stock

Slimflex Simple Insole Medium Density



Algeos Slimflex Wedge Kits

- Pre-moulded wedges, ready to be applied to the orthotic insole
- Kit contains:

3.5 deg Left rearfoot post	5 deg Left rearfoot post
3.5 deg Right rearfoot post	5 deg Right rearfoot post
	5 deg Forefoot wedge x 2

Slimflex Wedge Kits	Product Code	Size (UK)	Size (EUR)
Extra Small	SB4220	12 - 2.5	30 - 35
Small	SB4222	6 - 6.5	36 - 40
Medium	SB4224	7 - 10.5	41 - 44
Large	SB4226	11 - 14.5	45 - 52



Sold as a pack.

Algeos DuoSoft Therapeutic Insoles

- Designed to provide cushioning, accommodation and absorbency required for the diabetic/insensate foot
- Anatomically designed to facilitate off-loading of the metatarsal head area
- Plastazote and urethane combination
- Thermo-insulation properties - good for cold feet, chilblains and vascular insufficiency
- Distinctive self contouring capabilities and hypoallergenic formulation customises to the foot to accommodate pressure hot spots

Algeos DuoSoft Therapeutic Insole	Size (UK)
SB2335	2 - 4.5
SB2336	5 - 6.5
SB2337	7 - 8.5
SB2338	9 - 10.5



Algeos DuoSoft Plus Insoles

- The ultimate soft cushioning insole - great for sensitive, arthritic and diabetic feet
- PORON 94 is a softer, lighter PORON with slower rebound - allows for more even distribution of body weight over the foot's plantar surface and offers fuller, richer cushioning
- Vylgel heel provides optimal shock attenuation
- Moulded cellular urethane for superior shock absorption, high resilience and cushioning

Algeos DuoSoft Plus Insole	Size (UK)
SB2402	2 - 4
SB2404	5 - 7
SB2406	8 - 9
SB2408	10 - 12
SB2410	13 - 15



Preformed EVA Insoles

Available direct from Sheffield stock

- Preformed insoles
- Full Length: available in low density sizes 35-48 or high density EVA sizes 36-48
- Optional additions are also available, please see below



FG-411
Full Length High EVA Insoles



FG-409
Full Length Low EVA Insoles

Preformed EVA Insoles	Product Code	Size (EUR)
Full Length High EVA Insoles	FG-411	36 - 48
Full Length Low EVA Insoles	FG-409	36 - 48
Additions	FG-AD	n/a

Optional Additions: Up to 5 additions from below can be added to Preformed EVA Insoles*.

Optional Additions	Product Code
Top Cover Poron® 3mm	1 FG-AD
Top Cover Spenco®	2 FG-AD
Forefoot Positioning 4° or 6° Medial or Lateral	3 FG-AD
Rearfoot Positioning 4° or 6° Medial or Lateral	4 FG-AD
Met Dome	5 FG-AD
Met Bar	6 FG-AD

*Please note that optional additions will incur an additional cost.

Algeos Heel Assist

- 5 layers of medium density EVA foam bonded together with a mild adhesive to provide quick and easy layer removal
- Allows the heel to lift to be adjusted to the required height
- Lightweight
- Easily adjustable
- Universal left or right
- Adjustable in 3mm layers from 3mm to 15mm
- Brushed nylon top cover

Heel Assist	Product Code	Size (UK)
Small	SC3448	3 - 6
Medium	SC3449	7 - 9
Large	SC3450	10 +



Algeos Clearly Adjustable Heel Lift

Available direct from Sheffield stock

- Used to help alleviate the symptoms associated with leg length discrepancy
- Long constant slope supports the arch and avoids bridging the heel and ball of the foot, reducing stress
- Height can be adjusted from 2mm to 12mm
- Trim to fit with scissors
- Patented design
- Clear vinyl material does not compress and retains heel height

Clearly Adjustable Heel Lift	Product Code	Size (UK)
Small	SC2991	Up to 5.5
Medium	SC2992	Up to 8
Large	SC2993	8.5 +



Algeos LLD Posted Heel Lift

- Tapered design for less of a 'drop off'
- Shore A65 high density EVA

Algeos LLD Posted Heel Lift (Pair)	Product Code 5mm	Product Code 10mm	Product Code 12mm	Product Code 15mm	Size
Small	SB4074B	SB4079B	SB4094B	SB4082B	4 - 6
Medium	SB4076B	SB4080B	SB4095B	SB4083B	7 - 9
Large	SB4078B	SB4081B	SB4096B	SB4084B	10+



Orthotix Orliman Insole with Fabric Cover Available direct from Sheffield stock

- Insoles recommended for sore or tired feet, during sporting activity or post surgery
- Dual density composition uses visco elastic properties and softer blue areas to cushion the foot's vital pressure points
- 100% silicone which is naturally hypoallergenic and can be washed in cold water
- The heel cups are especially recommended for plantar fasciitis

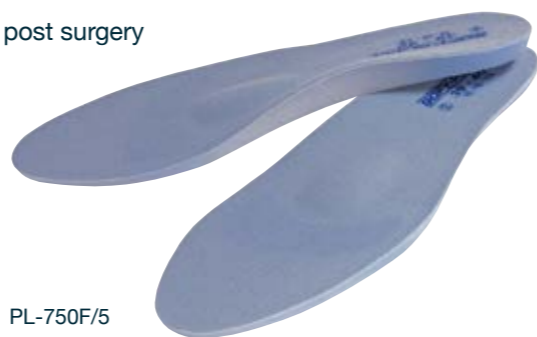

Orthotix Orliman Insole with Fabric Cover - Full Length Lined Silicone Insoles

Product Code	PL-750F/0	PL-750F/1	PL-750F/2	PL-750F/3	PL-750F/4	PL-750F/5
Size	35 - 36	37 - 38	39 - 40	41 - 42	43 - 44	45 - 46

Promedics Epoda Dual Heel Pads

- Dual density wedge shaped design with integral extra soft blue area



Epoda Dual Heel Pads

Size	UK Shoe Size	Product Code (5mm Thick)	Product Code (10mm Thick)
Small	4 - 5	EPB/53	EPB/103
Medium	6 - 7	EPB/55	EPB/105
Large	8 - 9	EPB/57	EPB/107
Extra Large	10 - 11	EPB/58	EPB/108

Algeos WonderCup Dual Density Heel Cups Available direct from Sheffield stock

- Dual density silicone provides relief to entire heel
- Aids in bursitis, achilles tendonitis, pressure ulcers, and plantar fasciitis
- Hypoallergenic and latex free



WonderCup Dual Density Heel Cups

Size	Shoe Size (UK) - Ladies	Shoe Size (UK) - Mens	Product Code
Small	2.5 - 4.5	N/A	SI1256
Medium	4.5 - 7.5	6	SI1258
Large	8 - 9	7.5 - 9.5	SI1260
Extra Large	10	10.5 - 13.5	SI1262

Algeos Wonderspur Soft Heel Cups Available direct from Sheffield stock

- Dual density silicone provides maximum support and shock absorption
- Helps with calcaneal spurs, plantar fasciitis, heel spurs, and knee and back pain
- Hypoallergenic and latex free



Wonderspur Soft Heel Cups

Size	Shoe Size (UK) - Ladies	Shoe Size (UK) - Mens	Product Code
Small	2.5 - 4.5	N/A	SI1248
Medium	4.5 - 7.5	6	SI1250
Large	8 - 9	7.5 - 9.5	SI1252
Extra Large	10	10.5 - 13.5	SI1254

Algeos Softzone 3/4 Length Insole Available direct from Sheffield stock

- Softer multi-density silicone absorbs shock under high pressure areas while supporting the rest of the foot
- Ideal as a replacement for shoes with removable insoles
- Relief for heel, arch, and forefoot problems
- Multiple vents enhance air circulation
- Hypoallergenic and latex free



Softzone 3/4 Length Insoles - Soft - Pair

Size	Shoe Size (UK) - Ladies	Shoe Size (UK) - Mens	Product Code
Small	2.5 - 4	N/A	SI1234
Medium	4.5 - 7.5	5 - 7	SI1236
Large	8 - 9.5	7.5 - 9.5	SI1238

Algeos Softzone Full Length Insole Available direct from Sheffield stock

- Softer multi-density silicone absorbs shock under high pressure areas while supporting the rest of the foot
- deal as a replacement for shoes with removable insoles
- Relief for heel, arch, and forefoot problems
- Multiple vents enhance air circulation
- Hypoallergenic and latex free



Softzone Full Length Insole - Pair

Size	Shoe Size (UK) - Ladies	Shoe Size (UK) - Mens	Product Code
Small	4 - 6.5	5.5 - 6	SI1240
Medium	7 - 9	6.5 - 9	SI1242
Large	9 - 10	9.5 - 11.5	SI1244
Extra Large	N/A	12 - 12.5	SI1246

Promedics PQ - 6mm Heel Lift

- Visco elastic polymer
- Shock absorbing properties
- 6mm raise for shortage accommodation
- Sold in single units



PQ - 6mm Heel Lift

Product Code	Shoe Size (UK)
L-PQ61	3 - 5
L-PQ62	6 - 8
L-PQ63	9 - 11

Promedics PQ - 9mm Heel Lift

- Visco elastic polymer
- Shock absorbing properties
- 9mm raise for shortage accommodation
- Sold in single units



PQ - 9mm Heel Lift

Product Code	Shoe Size (UK)
L-PQ91	3 - 5
L-PQ92	6 - 8
L-PQ93	9 - 11

Promedics Star Heel Pad

- 6mm thick visco elastic heel pad
- Unique star raise pattern improves dissipation of forces
- Well tapered towards pad edge

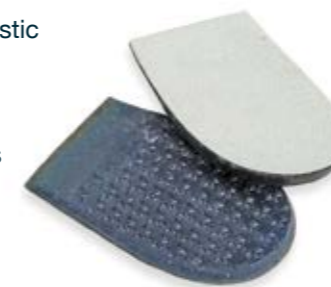

Star Heel Pad

Size	Product Code	Shoe Size (UK)
Small	L-SHPS	3 - 5
Medium	L-SHPM	6 - 8
Large	L-SHPL	9 - 11

Promedics Star Spur Pad

- 6mm thick visco elastic heel pad
- Unique star raise pattern improves dissipation of forces
- Well tapered towards pad edge
- Heel relief reduces pain associated with heel spurs and plantar fasciitis



Star Spur Pad

Size	Product Code	Shoe Size (UK)
Small	L-SSPS	3 - 5
Medium	L-SSPM	6 - 8
Large	L-SSPL	9 - 11

Promedics Silicone Gel Retractor/Protector

- Helps to realign the hallux valgus, preventing the first toe from overlapping the second
- Prevents rubbing between toes and reduces pain caused by callouses
- Sold singly



Silicone Gel Retractor/Protector

Product Code	Shoe Size (UK)
L-412	3 - 5
L-413	6 - 8
L-414	9 - 12

Algeos Heel/Elbow Slip Over

- Aids in the healing and skin conditioning of dry, cracked heels and elbows
- Versatile medical grade mineral oil gel pad can be positioned almost anywhere around the foot and heel
- 5mm of gel
- Effective in helping to prevent heel and elbow ulcerations
- Heel sleeve can be used in conjunction with pressure relief products to protect the skin
- Elbow sleeve provides ulnar nerve protection
- Hypoallergenic and latex free



Algeos Heel/Elbow Slip Over

Size	Product Code
Small	SI1482
Medium	SI1484
Large	SI1486

Algeos Single/Double/Triple Toe Splint

- One, two or three toe loop variations
- Foam padding
- Elastic loop to hold in place
- Product fits the right or left foot
- Dimensions: 22.86 x 15.24 x 1.59 cm



Algeos Single/Double/Triple Toe Splint

Size	Product Code - Single	Product Code - Double	Product Code - Triple Left	Product Code - Triple Right
One Size	SI3068	SI3070	SI3072	SI3072-R

Algeos Arthritic/Diabetic Gel Sock

- Provides optimum protection for the neuropathic foot
- Non-restrictive cuff
- Can be used with or without diabetic shoes
- Helps reduce friction, abrasion, and shear forces while preventing callus formation
- Single layer sock with 1/16" (2mm) of gel throughout the sole
- Helps prevent foot ulcerations
- Serves as a soft tissue supplement for fat pad atrophy
- Washable and reusable
- Sold in pairs



Algeos Arthritic/Diabetic Gel Sock - White

Description	Product Code	Shoe Size (UK)	Description	Product Code	Shoe Size (UK)
Pair - White	SI1214	Women 4 - 7/Men 4 - 6.5	Pair - Black	SI1220	Women 4 - 7/Men 4 - 6.5
Pair - White	SI1216	Women 7.5+/Men 7.5 - 9	Pair - Black	SI1222	Women 7.5+/Men 7.5 - 9
Pair - White	SI1218	Men 9.5 - 11	Pair - Black	SI1223	Men 9.5 - 11

Algeos Silopad Digital Cap

- Relieves pressure and friction
- Relieves painful ingrown toenails, corns, hammertoes and toe tips
- Fully lined with medical grade mineral oil gel to surround, soothe, moisturise, and protect
- Fits toes or fingers and can be cut to size
- Mesh fabric offers greater compression
- Hypoallergenic and latex free
- Soothes and eliminates pain, helping moisten toes or fingers
- Also helps to reduce the discomfort caused by blisters and in-shoe friction



Algeos Silopad Digital Cap

Size	Product Code
Mini	SI1374
Small/Medium	SI1376
Large/Extra Large	SI1378
Extra Extra Large	SI1380

Algeos Silipos Boot Bumper

- Helps protect the foot and ankle from abrasions without the added bulk.
- Effective in protecting against discomfort caused by ski boots, skates, studded boots, and other athletic footwear.
- Provides light compression to the foot and ankle.
- Hypoallergenic and latex free.



Algeos Silipos Boot Bumper

Size	Product Code
Small/Medium	SI1224
Large/Extra Large	SI1226

Algeos Therastep Gel Toe Protector

- Relieves pressure and friction
- Effective on ingrown toenails, corns, hammer toes and tips
- Soothes and moisturises
- Suitable for most shoe types and sizes
- Will not snag hosiery
- Washable and reusable
- Hypoallergenic and latex free



Algeos Therastep Gel Toe Protector

Size	Product Code
One Size	SI1296

Algeos Therastep Gel Toe Spacers

- Separates and cushions toes
- Effective on bunions and overlapping toes
- Aligns big toe and reduces pain
- Suitable for most shoe types and sizes
- Will not snag hosiery
- Washable and reusable
- Hypoallergenic and latex free



Algeos Therastep Gel Toe Spacers - Pack of 2

Size	Product Code
One Size	SI1298

Algeos Therastep Achilles Heel Pad

- Relieves pressure and friction
- Effective on achilles tendonitis, bursitis, heel pain, and pump bump
- Soothes and moisturises
- Suitable for most shoes, athletic footwear, ski boots, skates, and cleats
- Fits right or left foot
- Washable and reusable
- Hypoallergenic and latex free



Algeos Therastep Achilles Heel Pad

Size	Product Code
One Size	SI1318

Algeos Therastep Gel Toe Tube

- Relieves pressure and friction
- Effective on corns, calluses, blisters, and ingrown toenails
- Soothes and moisturise - contains soothing vitamin e and aloe vera
- Suitable for most shoe types and sizes
- Will not snag hosiery
- Washable and reusable
- Hypoallergenic and latex free



Algeos Therastep Gel Toe Tube - Pack of 2

Size	Product Code
One Size	SI1306

Algeos All Gel Digital Cap

- Relieves pressure and friction
- Helps reduce discomfort caused by corns, blisters, and ingrown nails
- Cushions, soothes and moisturises
- Latex free and hypoallergenic



Algeos All Gel Digital Cap - Pack of 2

Size	Product Code
Small/Medium	SI1420
Large/Extra Large	SI1422

Algeos Silopad Gel Foot Cover

- Ideal for activities that place stress on toes and metatarsals
- Medical grade mineral oil gel covered with fabric offers complete toe protection
- Extends to provide protection and cushioning to the metatarsal heads
- Designed to be worn comfortably with everyday footwear and underneath hosiery
- Hypoallergenic and latex free
- Washable and reusable



Algeos Silopad Gel Foot Cover - Pair

Size	Product Code	Measurements
Small	SI1386	9.5cm x 12.5cm
Medium	SI1388	10cm x 13.5cm
Large	SI1390	11cm x 15cm

Algeos Silopad Body Disc

- Multi-purpose discs of medical grade mineral oil gel
- Apply to parts of the body suffering from discomfort caused by pressure and friction
- The discs are available in 6.3cm or 10cm diameters and can be cut to preferred size for use in multiple applications to customised size
- Medical grade mineral oil gel moisturises and conditions the skin
- Hypoallergenic and latex free
- Washable and reusable



Algeos Silopad Gel Foot Cover - Pair

Size	Product Code
6.3cm Diameter	SI1392
10cm Diameter	SI1394

Algeos Silopad Achilles Heel Pad

- Soft conforming gel pad protects the posterior of the heel from pressure, impact, and friction
- Provides gentle compression and dissipation of pressure around inflamed are
- Effective in protecting against discomfort caused by ski boots, skates, studded boots, other athletic footwear, shoes, and boots
- Reduces pain caused by footwear pressure on irregular heel bumps
- Hypoallergenic and latex free
- Washable and reusable



Algeos Silopad Achilles Heel Pad - Singles

Size	Product Code
Small/Medium	SI1402
Large/Extra Large	SI1404

Algeos Silopad Softsock

- Indicated for neuropathic and rheumatoid arthritis sufferers
- Excellent for any condition that requires a soft, friction absorbing foot bed
- Fluid like properties of the gel help massage and comfort the foot while walking
- Effective in reducing shock and impact on the heel
- Double layer sock with 1/4" (6mm) of gel throughout the sole
- Serves as a soft tissue supplement for fat pad atrophy
- Requires extra depth footwear
- Not made with natural rubber latex and hypoallergenic
- Washable and reusable



Algeos Silopad Softsock

Description	Size	Product Code	Shoe Size (UK)
Pair - White	Small	SI1424	Women 5 - 7/Men 6.5 - 8.5
Pair - White	Medium	SI1426	Women 7 - 9/Men 8.5 - 10.5
Pair - White	Large	SI1428	Women 8 - 10/Men 9.5 - 12.5

Algeos Bunion Care Gel Sleeve

- Anatomically designed to comfortably conform to the shape of the bunion
- Cushions, protects, and reduces pressure on the affected area with medical grade mineral oil gel pad
- Helps to reduce scarring after surgery
- Washable and reusable
- Hypoallergenic and latex-free



Algeos Bunion Care Gel Sleeve

Size	Product Code
Small/Medium	SI1396
Large/Extra Large	SI1398

Algeos Gel Toe Spreader

- Aligns big toe to help reduce pain
- Effective on bunions and overlapping toes
- Separates toes to relieve pressure and friction
- Used as an inter-digital wedge for bunion deformity, overlapping toes, or toe drift
- Hypoallergenic and not made with natural rubber latex
- BPA and Phthalate free
- Washable and reusable



Algeos Gel Toe Spreader

Size	Pack Size	Product Code
Small	4	SI1454
Medium	4	SI1456
Large	4	SI1458
Small	15	SI1460
Large	15	SI1462

Algeos Gel Toe Crest

- Helps to relieve pressure and pain caused by hammer, claw, and mallet toes
- Absorbs shock and provides even pressure distribution
- Reinforced toe loop to ensure proper fit
- Will not bottom out like foam products
- Hypoallergenic and latex free
- Washable and reusable



Algeos Silopad Gel Foot Cover - Pack of 3

Size	Product Code Left	Product Code Right
Small	SI1536	SI1538
Large	SI1540	SI1542

Algeos Deluxe Suede Hammer Toe Crest

- Soft suede is gentle against the skin
- Anatomically designed to help reduce pain in the toes and metatarsals
- Fits most shoe types
- Adjustable toe loop which holds spacer in place for use with or without shoes



Algeos Deluxe Suede Hammer Toe Crest

Size	Product Code Left	Product Code Right
Small	SI3080	SI3082
Medium	SI3084	SI3086
Large	SI3088	SI3090

Algeos Active Gel Toe Protector

- Relieves pressure and friction
- Effective on ingrown toenails, corns, hammer toes, and tips
- Fully lined with medical grade mineral oil gel to surround, soothe, moisturise, and protect
- Fits toes or fingers and can be cut to size
- Suitable for most shoe types and sizes
- Will not snag hosiery
- Washable and reusable
- Latex free and hypoallergenic



Algeos Active Gel Toe Protector

Size	Product Code
One Size	SI1612

Algeos Active Gel Toe Spacers

- Aligns big toe to help reduce pain
- Effective on bunions and overlapping toes
- Separates toes to relieve pressure and friction
- Used as an interdigital wedge for bunion deformities, overlapping toes, or toe drift
- Will not snag hosiery
- Washable and reusable
- Latex free and hypoallergenic



Algeos Active Gel Toe Spacers - Pack of 2

Size	Product Code
One Size	SI1614

Algeos Active Gel Toe Separators

- Relieves pressure and friction between toes.
- Anatomically designed to fit comfortably between toes.
- Gently divides, cushions, and, aligns toes.
- Helps correct overlapping toes.
- Will not snag hosiery.
- Washable and reusable.
- Latex free and hypoallergenic.



Algeos Active Gel Toe Separators - Pack of 2

Size	Product Code
One Size	SI1616

Algeos Malleolar Gel Sleeve

- Cushions and protects the ankle against impact, pressure, and abrasion
- Designed with two discs of gel moulded on both the medial and lateral malleolae
- Provides gentle compression to the ankle
- Effective in protecting against discomfort caused by ski boots, skates, studded boots, and other athletic footwear
- Hypoallergenic and latex free
- Washable and reusable



Algeos Malleolar Gel Sleeve

Size	Product Code
One Size	SI1480

Algeos Deluxe Gel Bunion Sleeve

- Unique pressure relief hole surrounds the bunion to minimize friction and rubbing
- Soothing mineral oil gel pad sits comfortably around the bony protrusion
- Cushions, and protects
- Absorbs pressure and friction
- Thin design fits most footwear and can be worn under hosiery
- Washable and reusable
- Dimensions: 9 x 6 x 0.25 inches



Algeos Deluxe Gel Bunion Sleeve

Size	Product Code
One Size	SI1510

Algeos Gel Splint

- Hook and loop makes splint easy to apply with one hand
- Contains medical grade mineral oil which soothes and moisturizes the skin
- Can be worn underneath socks and in shoes
- Washable and reusable
- Not made with natural rubber latex and hypoallergenic
- BPA and Phthalate Free
- Dimensions: 14.61 x 5.08 x 14.61cm



Algeos Gel Splint - Pack of 2

Size	Product Code - Beige	Product Code - Black
One Size -	SI1528	SI1530

Algeos Flexi Diabetic Gel Sock

- Moulded with shock absorbing solid gel insole
- Comfort, cushion, and protect
- Helps reduce friction, abrasion, shear forces, and callus formation
- Helps prevent foot ulcerations
- Serves as soft tissue supplement for fat pad atrophy
- Conforms to the shape of your foot
- Use with or without diabetic shoes
- Optimum protection for the neuropathic foot



Algeos Flexi Diabetic Gel Sock

Description	Size	Product Code	Shoe Size (UK)
Pair - Black	Medium	SI1556	Women 7.5+/Men 7.5 - 9
Pair - Black	Large	SI1558	Men 9.5 - 11

Algeos Plantar Fasciitis Arch Sleeve

- Easy slip-on sleeve can be worn with or without shoes
- Clinically proven to reduce pain from plantar fasciitis, tendonitis, heel spurs, and heel neuromas
- Reduces heel and foot pain
- Will not snag hosiery
- Washable and reusable



Algeos Plantar Fasciitis Arch Sleeve

Size	Product Code Left	Product Code Right
One Size	SI0066	SI0068

Algeos Gel Toe Sandal Spreader

- Small and sleek gel cushion fits easily around toe stand of sandals and flip flops
- Cushions between toes and prevents friction for comfortable all day use
- Peel and stick bottom helps keep gel cushion in place
- Clear and slim design is barely noticeable
- Hypoallergenic and latex free
- Washable and reusable



Algeos Gel Toe Sandal Spreader - Pack of 2

Size	Product Code
One Size	SI0064

Algeos No-Slip All Gel Toe Spacer

- Separates and aligns the big toe
- Loop holds spacer in place for use with or without shoes
- Effective on overlapping toes, crooked toes and bunion pain
- Gel cushions the toe, absorbing pressure and friction
- Hypoallergenic and latex free
- Washable and reusable



Algeos No-Slip All Gel Toe Spacer - Pack of 4

Size	Product Code
One Size	SI1582

Algeos Active Gel Achilles Heel Sleeve

- Relieves pressure and friction
- Effective on achilles tendonitis, bursitis, heel pain, and pump bump
- Soothes and moisturises
- Suitable for most shoes, athletic footwear, ski boots, skates, and studded boots
- Fits right or left foot
- Washable and reusable
- Latex free and hypoallergenic
- Black design is more modern and less noticeable



Algeos Active Gel Achilles Heel Sleeve

Size	Product Code
One Size	SI1628

Algeos No-Slip Buddy Spacer

- Separates and aligns the big toe
- Loops hold spacer in place for use with or without shoes
- Effective on overlapping toes, crooked toes and bunion pain
- Gel cushions the toe, absorbing pressure, and friction
- Hypoallergenic and latex free



Algeos No-Slip Buddy Spacer - Pack of 4

Size	Product Code
One Size	SI1570

Algeos Bunion Guard with Spacer

- Reduces bunion pain
- Separates and aligns the toes
- Soft gel absorbs pressure and friction on the bunion
- Fits right or left foot
- Hypoallergenic and latex free



Algeos Bunion Guard with Spacer

Size	Product Code
One Size	SI1574

Algeos Bunion Guard with Buddy Spacer

- Reduces bunion pain
- Separates and aligns the toes
- Soft gel absorbs pressure and friction on the bunion
- Fits right or left foot
- Hypoallergenic and latex free



Algeos Bunion Guard with Buddy Spacer

Size	Product Code
One Size	SI1578

Brace Orthopaedic Halluxsan®

- Active Dynamic Hallux Valgus Brace
- Therapy in the physiological position of the big toe
- Individual adjustment of the tension spring without tools
- Individual adjustment of the straps
- Easy handling and high wearing comfort



Corrective Force	Spring setting	1	2	3	4	5
	Torque in Nm	1.1	1.6	3.1	4.9	6.8

Halluxsan®

Colour	Product Code (Left)	Product Code (Right)
Black	940AS-L	940AS-R
Green	940A-L	940A-R
Pink	940AP-L	940AP-R
Grey	940AG-L	940AG-R

Halluxsan comes in one size only, either right or left.

Promedics Universal Soft Hallux Valgus

- A soft padded universal size splint
- Helps maintain the large toe in a neutral position
- Easy to apply with adjustable hook and loop fastening
- Adjustable aluminum stay provides stability and assists in the positioning of the alignment of the large toe
- Can be worn at night or during the day in footwear



Universal Soft Hallux Valgus

Size	Product Code (Left)	Product Code (Right)
Universal	JSHV/L	JSHV/R



Orthotix Orliman Boxia Drop Foot Splint Available direct from Sheffield stock

- Foot splint for discreet treatment of flaccid paralysis drop foot
- Consists of an ankle wrap with a non-slip hooked support section to fit between the tongue and shoelaces
- Adjustable elastic strap and interior gel padding for comfort around the Achilles tendon
- Available in black or beige
- Padded interior arch support also available

Boxia Ankle/Foot Orthosis

Size	Product Code - Black	Product Code - Beige	Length
Extra Small	BOX/XS	BBOX/XS	13 - 17cm
Small	BOX/S	BBOX/S	17 - 21cm
Medium	BOX/M	BBOX/M	21 - 25cm
Large	BOX/L	BBOX/L	25 - 29cm

Measurement above the malleoli.

Boxia Internal Strap

Size	Product Code - Black (Right)	Product Code - Black (Left)	Product Code - Beige (Right)	Product Code - Beige (Left)	Length
Small	BOX/INT/S/R	BOX/INT/S/L	BBOX/INT/S/R	BBOX/INT/S/L	17 - 21cm
Medium	BOX/INT/M/R	BOX/INT/M/L	BBOX/INT/M/R	BBOX/INT/M/L	21 - 25cm
Large	BOX/INT/L/R	BOX/INT/L/L	BBOX/INT/L/R	BBOX/INT/L/L	25 - 29cm

Measurement for the instep/arch area.



Ossur Foot Up

- A lightweight ankle-foot orthosis offering dynamic support for drop foot or similar conditions
- Provides visible improvement in gait by supporting the foot into dorsiflexion
- Cushioned ankle wrap made from a breathable, 3-layer material that can be worn comfortably for long periods of time
- Plastic inlay fits discreetly between the tongue and laces of the shoe, and is practically invisible when worn

Foot Up

Size	Product Code	Ankle Circumference
Size 1	07810-1	18 - 21cm
Size 2	07810-2	22 - 26cm
Size 3	07810-3	27 - 33cm

Spare Elastic Strap Black

Size	Product Code
Universal	17810

Black Shoeless Arch Support

Size	Product Code
Size 1	27810-1
Size 2	27810-2
Size 3	27810-3
Size 4	27810-4



Anatomical Concepts PRAFO

650APU Adult Available direct from Sheffield stock

- Adjustable upright section with calibrations
- Aluminium structure for extra strength
- Washable liner system
- Integral walking base
- Also available in paediatric sizing, see page 151

PRAFO 650APU	Size
652SKG	Adult



Anatomical Concepts PRAFO

650RTBS Adult Available direct from Sheffield stock

- Zero heel pressure
- Ambulatory and recumbent use
- Also available with dual action
- Washable liner system

PRAFO 650RTBS	Size
650RTBS	Adult



Anatomical Concepts PRAFO 650D Dual Action Adult Available direct from Sheffield stock

- Adjustable foot base (varus/valgus) with calibrations
- Adjustable upright section with calibrations
- Aluminium structure for extra strength
- Washable liner system

PRAFO 650D	Size
653SKG	Adult



Anatomical Concepts PRAFO Replacement Liners and Calf Strap Available direct from Sheffield stock

- Replacement liners and calf straps available for adult PRAFOs
- Also available in paediatric sizing, see page 151

PRAFO Replacement Liners and Straps

Size	Product Code
Adult	L60SKG



Promedics Ankle Contracture AFO Available direct from Sheffield stock

- Ankle foot orthosis that provides heel suspension and assists in the treatment and prevention of pressure sores
- Easily applied walking sole with no bolts or screws
- Soft, padded material absorbs moisture away from the skin
- Transparent frame for viewing heel
- Regular version: 33cm height
- Washable soft goods and mesh laundry bag

Ankle Contracture Boot				Replacement Liners		
Size	Product Code	Heel to Toe	Calf Cuff	Foot Cuff	Size	Product Code
Small/Medium	LEB/S	20 - 28cm	33 - 43cm	25 - 33cm	Small	LEB/S/L
Large	LEB/R	25 - 30cm	33 - 43cm	30 - 38cm	Large	LEB/R/L



Ossur DynaPro® AFO Available direct from Sheffield stock

- Effectively reverses ankle/foot contractures
- Elastic pull straps effectively treat plantar flexion, inversion or eversion
- Non-skid bottom for assisted transfers

DynaPro® AFO			
Size	Product Code	Foot Length	Max. Calf Circumference
Small	DPAFO21S	15 - 20cm	38cm
Medium	DPAFO22M	20 - 25cm	43cm
Large	DPAFO23L	25 - 30cm	48cm



NeuroFlex® Restorative Flex Boot

- Flex Technology splint moves with the patient's abnormal muscle tone and spasticity
- Dorsiflexion assist (flex) straps with adjustable tension to help control plantar flexion
- Anti-rotation bar
- High temperature, remouldable plastic base
- Open heel and non-slip sole

NeuroFlex® Restorative Flex Boot		
Size	Product Code	Foot Length
Small	RM0132	Up to 20cm
Medium	RM0134	Up to 24cm
Large	RM0136	Up to 28cm
Extra Large	RM0138	Up to 33cm



RM Safe Boot II with Flex Strap

- Flex Technology splint moves with the patient's abnormal muscle tone and spasticity
- Dorsiflexion assist (flex) straps aid in proper alignment of the foot and adjustable tension helps to control plantar flexion
- Anti-rotation bar can be stored inside the padding if not needed
- Toe support with 'toe off' angle to assist in gait training and short ambulation
- High temperature, remouldable plastic base
- Open heel and non-slip sole

RM Safe Boot II with Flex Strap		
Size	Product Code	Foot Length
Small	RM0174	Up to 20cm
Medium	RM0176	Up to 24cm
Large	RM0178	Up to 28cm
Extra Large	RM0180	Up to 33cm



Promedics Heal-up® Protection Boot

- Offloads heel to prevent and manage ulcers
- Simple and effective closure straps
- Floats the heel
- Open heel provides visibility with additional opening for greater inspection visibility
- Universal size, left or right
- Treated with Agion® and Silvadur™ antimicrobial to inhibit the growth of bacteria



Heal-up® Protection Boot

Size	Quantity	Product Code
Universal	1	HUP/10

Promedics Swedish Ankle Foot Orthosis Available direct from Sheffield stock

- Provides static dorsiflexion assistance and lateral stability for the ankle/foot area
- Made in polythene, thicker on the vertical aspect for rigidity and thinner on the footplate to allow for trimming
- Low arch and open heel give a neat shape, which fits into a shoe easily
- Calf section padded for comfort
- Can be trimmed to size with scissors and shaped with a heat gun



Swedish Ankle Foot Orthosis

Size	Product Code (Left)	Product Code (Right)	Shoe Size (UK)
Small	TO4302/SSX	TO4302/SDX	3 - 6
Medium	TO4302/MSX	TO4302/MDX	7 - 8.5
Large	TO4302/LSX	TO4302/LDX	7.5 - 10
Extra Large	TO4302/XLSX	TO4302/XLDX	11+

Promedics Reinforced Swedish Ankle Foot Orthosis Available direct from Sheffield stock

- Lightweight carbon reinforced plastic leaf spring orthosis
- Footplate easily trimmed
- Incorporates carbon that improves memory and increases dorsiflexion assist
- Supplied with easy to attach instep strap



Reinforced Swedish Ankle Foot Orthosis - Extra Strong

Size	Product Code (Left)	Product Code (Right)
Small	TO4302CSSX	TO4302CSDX
Medium	TO4302CMSX	TO4302CMDX
Large	TO4302CLSX	TO4302CLDX
Extra Large	TO4302CXLX	TO4302CXLDX

Beagle Orthomerica Leaf Spring Orthosis

- Popular prefabricated design accommodates many patients not requiring a custom or more rigid AFO
- Fits in most normal lace-up shoes
- Low profile for excellent cosmetics
- Easily trimmed and heated for a more custom fit
- Economical solution

Beagle Orthomerica Leaf Spring Orthosis

Size	Product Code (Left)	Product Code (Right)	Footplate Length (mm)	Brace Height (mm)	Shoe Size (UK)
Small	B/3510	B/3515	160	300	5 - 7
Medium	B/3511	B/3516	160	340	7½ - 10
Large	B/3512	B/3517	170	340	10½ - 13
Extra Large	B/3513	B/3518	190	355	13+



Beagle Orthomerica Fixed Ankle Orthosis

- Standard AFO design pre-fabricated from polypropylene to 1/8" thickness for necessary rigidity and comfort
- Can be heated for further modification and an individual fit
- Versatile design containing posterior ribs for increased support

Beagle Orthomerica Fixed Ankle Orthosis

Size	Product Code (Left)	Product Code (Right)	Footplate Length (mm)	Brace Height (mm)	Shoe Size (UK)
Small	B/3540	B/3545	160	300	5 - 7
Medium	B/3541	B/3546	160	340	7½ - 10
Large	B/3542	B/3547	170	340	10½ - 13
Extra Large	B/3543	B/3548	190	355	13+



Turtlebrace Ankle

- 'Apply and forget' type brace made of a stratification of multi-perforated low-temperature thermoplastic and microfibre fabric
- Flexibility of components stabilises joint more easily and precisely than a traditional brace or cast
- Can be reshaped multiple times, without losing its qualities - allows adjustment due to swelling or morphological changes



Turtlebrace Ankle

Size	Product Code - Standard	Product Code - Reinforced	Ankle Circumference
Adult - Small	TBCA-01	TBCAR-01	20.3cm - 34cm
Adult - Medium	TBCA-02	TBCAR-02	21.6cm - 36.2cm
Adult - Large	TBCA-03	TBCAR-03	22.9cm - 38.4cm



Marmed Drop Foot Splint Full Foot

- Lightweight posterior leaf spring AFO
- Strong rigid polypropylene shell with hook and loop calf strap
- Easy to trim foot plate
- Low profile at ankle for comfort
- Shell aids stability and limits rotation
- Places foot in moderate pronation and dorsi-flexion
- Full foot provides additional support and comfort

Marmed Drop Foot Splint Full Foot

Size	Product Code (Left)	Product Code (Right)	Footplate Length (mm)	Brace Height (mm)
Small	CPLSFF-S-L	CPLSFF-S-R	215	330
Medium	CPLSFF-M-L	CPLSFF-M-R	250	345
Large	CPLSFF-L-L	CPLSFF-L-R	280	345
Extra Large	CPLSFF-XL-L	CPLSFF-XL-R	290	380

Marmed Drop Foot Splint Full Foot - Additional Splint Strap

Size	Product Code
One Size	CPLSFFSTRAP



Marmed Drop Foot Splint ¾ length

- Lightweight posterior leaf spring AFO
- Strong rigid polypropylene shell with hook and loop calf strap
- Easy to trim foot plate
- Low profile at ankle for comfort
- Shell aids stability and limits rotation
- Places foot in moderate pronation and dorsi-flexion
- ¾ length version allows for easier fit inside foot wear

Marmed Drop Foot Splint ¾ length

Size	Product Code (Left)	Product Code (Right)	Footplate Length (mm)	Brace Height (mm)
Small	CPLSC-S-L	CPLSC-S-R	145	330
Medium	CPLSC-M-L	CPLSC-M-R	160	355
Large	CPLSC-L-L	CPLSC-L-R	185	355
Extra Large	CPLSC-XL-L	CPLSC-XL-R	195	380



Allard Boston Soft AFO

- Lightweight resting splint
- Inexpensive alternative to a custom AFO
- Manufactured from 3mm soft-feel polyethylene foam with a 3mm polypropylene heel insert
- Fully adjustable and easily trimmed with scissors
- Also available in paediatric sizing, see page 150

Allard Boston Soft AFO

Product Code - Adult with Stabiliser	Product Code - Adult without Stabiliser	Shoe Size (UK)	Shoe Size (EU)
AFO-AS	AFO-A	1-2	32-34
AFO-BS	AFO-B	3-4	35-36
AFO-CS	AFO-C	5-6	37-39
AFO-DS	AFO-D	7-8	40-41
AFO-ES	AFO-E	9-10	42-44
AFO-FS	AFO-F	11-12	45-46



Promedics Universal Plantar Faciitis Orthosis

Available direct from Sheffield stock

- Holds foot in dorsiflexion and allows load application to soft tissues of plantar fascia and achilles tendon
- Dorsi flexion easy to adjust using double hook and loop straps additional wedges (3 supplied)
- Fits left and right
- Replacement liners available



Universal Plantar Faciitis Orthosis

Size	Product Code	Replacement Liners Code	Shoe Size (UK)
Small	UFO/S	UFO/S-L	3 - 5.5
Medium	UFO/M	UFO/M-L	6 - 9
Large	UFO/L	UFO/L-L	9.5 - 11



Promedics AFO-1 Classic Medial/KT

- Premium quality pre-preg carbon fibre AFO
- Strong, durable and lightweight
- Hook and loop closure, with return loop
- Sole can be easily adapted to accommodate different shoes
- 100kg maximum body weight tolerance
- Available in right or left



AFO-1 Classic Medial/KT

Product Code Left	Product Code Right	Size	Shoe Size (EUR)	Length (Tolerance +/- 2mm)
KTAFO1/M/SL	KTAFO1/M/SR	Small	36 - 39	253mm
KTAFO1/M/ML	KTAFO1/M/MR	Medium	39 - 42	275mm
KTAFO1/M/LL	KTAFO1/M/LR	Large	42 - 45	293mm
KTAFO1/M/XLL	KTAFO1/M/XLR	Extra Large	45 - 47	300mm

Promedics AFO-1 Classic Lateral/KT

- Premium quality pre-preg carbon fibre AFO
- Strong, durable and lightweight
- Hook and loop closure, with return loop
- Sole can be easily adapted to accommodate different shoes
- 100kg maximum body weight tolerance
- Available in right or left



AFO-2 Classic Lateral/KT

Product Code Left	Product Code Right	Size	Shoe Size (EUR)	Length (Tolerance +/- 2mm)
KTAFO1/L/SL	KTAFO1/L/SR	Small	36 - 39	253mm
KTAFO1/L/ML	KTAFO1/L/MR	Medium	39 - 42	275mm
KTAFO1/L/LL	KTAFO1/L/LR	Large	42 - 45	293mm
KTAFO1/L/XLL	KTAFO1/L/XLR	Extra Large	45 - 47	300mm

Promedics AFO-3 Flexible

- Premium quality pre-preg carbon fibre AFO
- Spiral structure for resistance and elasticity
- Strong, durable and lightweight
- Hook and loop closure, with return loop
- Sole can be easily adapted to accommodate different shoes
- 100kg maximum body weight tolerance
- Available in right or left



Promedics AFO-3 Flexible

Product Code Left	Product Code Right	Size	Shoe Size (EUR)	Length (Tolerance +/- 2mm)
PRAFKT3/13	PRAFKT3/23	Small	36 - 39	253mm
PRAFKT3/15	PRAFKT3/25	Medium	39 - 42	275mm
PRAFKT3/17	PRAFKT3/27	Large	42 - 45	293mm

Promedics AFO -4 Anterior Carbon AFO

- Lightweight and low profile
- 100% premium quality pre-preg carbon fibre
- Features an anterior moulded rigid shell with comfortable padding
- Provides dorsiflexion assist during swing phase
- 'Easy Fit' fully trimmable sole plate
- 100kg maximum body weight tolerance



Promedics AFO -4 Anterior Carbon AFO

Product Code Left	Product Code Right	Size	Length (Tolerance +/- 2mm)	Shoe Size (EUR)
PREGFIX/AFO/SL	PREGFIX/AFO/SR	Small	253mm	36 - 39
PREGFIX/AFO/ML	PREGFIX/AFO/MR	Medium	275mm	39 - 42
PREGFIX/AFO/LL	PREGFIX/AFO/LR	Large	293mm	42 - 45

Ossur AFO Dynamic

- Incorporates Flex-Foot® technology
- Carbon fibre provides excellent strength to-weight ratio, energy return and dynamic motion
- Open anterior tibia shell provides superior anatomical fit, and reduces heat and perspiration
- 120kg maximum body weight tolerance

AFO Dynamic Accessory Description	Product Code
Extra Small Accessory Pack	O-102101
Small Accessory Pack	O-102102
Medium Accessory Pack	O-102104
Large Accessory Pack	O-102106

AFO Dynamic

Product Code Access Left	Product Code Access Right	Size	Calf Height	Shoe Size (UK) - Male	Shoe Size (UK) - Female
O-102021	O-102011	Extra Small	300 - 340mm	2.5 - 4.5	Up to 4
O-102022	O-102012	Small	320 - 360mm	5 - 7	4.5 - 6.5
O-102024	O-102014	Medium	340 - 380mm	7.5 - 10	7 - 9.5
O-102026	O-102016	Large	360 - 400mm	10.5 - 13.5	N/A



Ossur AFO Light

- Incorporates Flex-Foot® technology
- Strong and lightweight solution, providing support only where it is needed
- Eliminates unnecessary bulk with a cosmetically-appealing look
- Carbon fibre provides excellent strength-to-weight ratio, energy return and dynamic motion
- Easy to don and doff
- 100kg maximum body weight tolerance

AFO Light

Product Code Left	Product Code Right	Size	Calf Height	Shoe Size (UK) - Male	Shoe Size (UK) - Female
O-121022	O-121012	Small	320 - 360mm	Up to 7	4.5 - 6.5
O-121024	O-121014	Medium	340 - 380mm	7.5 - 10	7 - 9.5
O-121026	O-121016	Large	360 - 400mm	10.5 - 13.5	N/A
O-121028	O-121018	Extra Large	380 - 420mm	11.5 - 14.5	N/A

AFO Light Accessory Description	Product Code
Replacement Pad & Strap Kit	O-122101



Thrive Orthopedics® F3 Anterior AFO

- Dorsiflexion assist and Plantarflexion control
- Aerospace-grade carbon fibre construction
- Lightweight dynamic support with an enhanced, ultra-secure fit
- Thermal-formed, moisture-wicking padding with a tibia- relief channel for high levels of comfort
- Lateral strut design avoids contact with the ankle bone

Thrive Orthopedics® F3 Anterior AFO

Product Code Left	Product Code Right	Size	Shoe Size (UK)	Footplate Length	Brace Height
PH-F3-LT-XS F3	PH-F3-RT-XS F3	Extra Small	4.5 - 6.5	225mm	325mm
PH-F3-LT-S F3	PH-F3-RT-S F3	Small	6.5 - 9	244mm	350mm
PH-F3-LT-M F3	PH-F3-RT-M F3	Medium	9.5 - 10.5	269mm	375mm
PH-F3-LT-L F3	PH-F3-RT-L F3	Large	11 - 12.5	275mm	400mm
PH-F3-LT-XL F	PH-F3-RT-XL F3	Extra Large	13 - 15.5	294mm	425mm



Thrive Orthopedics® F5 Spiral AFO

- Dorsiflexion assist and flexibility for Plantar Flexion
- Aerospace-grade carbon fibre construction
- Lightweight dynamic support with an enhanced, ultra-secure fit
- Thermal-formed, moisture-wicking padding with a tibia- relief channel for high levels of comfort
- Lateral strut design avoids contact with the ankle bone

Thrive Orthopedics® F5 Spiral AFO

Product Code Left	Product Code Right	Size	Shoe Size (UK)	Footplate Length	Brace Height
PH-F5-LT-XS F5	PH-F5-RT-S F5	Extra Small	4 - 6	222mm	300mm
PH-F5-LT-S F5	PH-F5-RT-S F5	Small	6.5 - 8	241mm	325mm
PH-F5-LT-L F5	PH-F5-RT-M F5	Medium	8.5 - 10.5	263mm	350mm
PH-F5-LT-L F5	PH-F5-RT-L F5	Large	11 - 13	281mm	375mm
PH-F5-LT-XL F5	PH-F5-RT-XL F5	Extra Large	14 - 16	300mm	400mm



Thrive Orthopedics® F5 Medial AFO

- Dorsiflexion assist and flexibility for Plantar Flexion
- Aerospace-grade carbon fibre construction
- Lightweight dynamic support with an enhanced, ultra-secure fit
- Thermal-formed, moisture-wicking padding with a tibia- relief channel for high levels of comfort
- Medial strut placement provides a comfortable and intimate fit for users with lateral ankle instability

Thrive Orthopedics® F5 Medial AFO

Product Code Left	Product Code Right	Size	Shoe Size (UK)	Footplate Length	Brace Height
PH-F5-MS-LT-XS F5	PH-F5-MS-RT-XS F5	Extra Small	4 - 6	222mm	300mm
PH-F5-MS-LT-S F5	PH-F5-MS-RT-S F5	Small	6.5 - 8	241mm	325mm
PH-F5-MS-LT-M F5	PH-F5-MS-RT-M F5	Medium	8.5 - 10.5	263mm	350mm
PH-F5-MS-LT-L F5	PH-F5-MS-RT-L F5	Large	11 - 13	281mm	375mm
PH-F5-MS-LT-XL F5	PH-F5-MS-RT-XL F5	Extra Large	14 - 16	300mm	400mm



Allard ToeOFF® AFO 2 & 2.5

- Carbon composite dynamic response floor reaction AFO
- Keeps the foot up during swing phase whilst also giving a soft heel strike, stability in stance and good toe off
- Use in conjunction with SoftKIT and ComfortKIT interfaces (see below right)
- Available in two variants: ToeOFF® AFO 2 - 12-15mm heel height with full toe lift
ToeOFF® AFO 2.5 - 7mm heel height with less toe lift



Allard ToeOFF® AFO 2.5 Flow

- For your active patients or others who require less resistance or more ROM.
- The new FLOW technology offers a smoother transition (flow) throughout the gait cycle and has increased ROM in the sagittal plane.
- ToeOFF® Flow 2½ has a lower heel height (approx. 7mm) which accommodates gentler contours of shoe insoles and offers more clearance for the forefoot in the shoe.

ToeOFF® AFO 2		ToeOFF® AFO 2.5		ToeOFF® AFO 2.5 Flow		Size	Footplate Length	Height
Product Code Left	Product Code Right	Product Code Left	Product Code Right	Product Code Left	Product Code Right			
289201010	289202010	289801010	289802010	289601010	289602010	Extra Small	21cm	36cm
289201011	289202011	289801011	289802011	289601011	289602011	Small	23cm	38cm
289201012	289202012	289801012	289802012	289601012	289602012	Medium	24.5cm	40.5cm
289201013	289202013	289801013	289802013	289601013	289602013	Large	27cm	43cm
289201014	289202014	289801014	289802014	289601014	289602014	Extra Large	28.5cm	45cm

Allard BlueROCKER® AFO 2 & 2.5

- Identical to ToeOFF® AFO but offers more rigid control
- Extra stability provides improved balance, posture and security
- Suitable for use with a socket and toe filler for partial amputations
- Use in conjunction with SoftKIT and ComfortKIT interfaces (see below)
- Available in two variants: BlueROCKER® AFO 2 - 12-15mm heel height with full toe lift
BlueROCKER® AFO 2.5 - 7mm heel height with less toe lift
- Also available in paediatric sizing, see page 151



BlueROCKER® AFO 2		BlueROCKER® 2.5 AFO		Size	Footplate Length	Height
Product Code Left	Product Code Right	Product Code Left	Product Code Right			
289401010	289402010	289701010	289702010	Extra Small	21cm	36cm
289401011	289402011	289701011	289702011	Small	23cm	38cm
289401012	289402012	289701012	289702012	Medium	24.5cm	40.5cm
289401013	289402013	289701013	289702013	Large	27cm	43cm
289401014	289402014	289701014	289702014	Extra Large	28.5cm	45cm

Allard Ypsilon® Flow ½ AFO

- Designed for active patients or others who require less resistance or more flexibility.
- Adapts and moves with the lower leg with less resistance to ground reaction forces
- Proximal ends of the 'Y' provide fixation points, eliminating pressure on the tibia crest
- 7mm heel height
- Also available in paediatric sizing, see page 151



Ypsilon® Flow ½ AFO					Ypsilon Flow ½ Tibial Pads	
Product Code Left	Product Code Right	Size	Footplate Length	Height	Size	Product Code
288801011	288802011	Small	23cm	38cm	Small/Medium/Large	288840012
288801012	288802012	Medium	24.5cm	40.5cm	Extra Large	288840014
288801013	288802013	Large	27cm	43cm	Ypsilon Flow ½ Strap	
288801014	288802014	Extra Large	28.5cm	45cm	Size	Product Code
					One Size	288850000

Allard CoverKIT™

- Sleeve combines SoftKIT™ interface with a thin textile front to slide over anterior shell
- Protects the skin and keeps brace in position
- Smooth surface extends down the strut to foot plate allowing pant legs to slide easily over the brace
- Includes two narrow neoprene pads to create a pressure-free channel to help relieve potential discomfort from bony prominences
- Can be used in conjunction with the straps supplied with the AFO

Product Code	Size	Calf Circumference
287650010	Extra Small	31 - 34cm
287650011	Small	34 - 37cm
287650012	Medium	37 - 41cm
287650013	Large	41 - 46cm
287650014	Extra Large	46 - 51cm



Allard Strap Sets For Toeoff®/BlueRocker® 2.0 & 2.5

- Comprising of upper and lower straps for ToeOFF®/BlueROCKER® 2.0 & 2.5 AFOs
- Can be used bilateral (opening on medial or lateral side)

Allard Strap Sets For Toeoff®/BlueRocker® 2.0 & 2.5	
Size	Product Code
Extra Small	287600010
Small	287600011
Medium	287600012
Large	287600013
Extra Large	287600014

Allard ToeOFF® Short Strap Set	
Size	Product Code
Small	287680011
Medium	287680012
Large	287680013



Allard MikroFIX™

- Replacement sets for SoftKIT™ and ComfortKIT™
- Pre-cut shapes used to adhere the SoftKIT™ or ComfortKIT™ to ToeOFF® or BlueROCKER® AFOs
- Include pressure sensitive backing for easy application

Replacement MikroFIX™ Kit for ToeOFF®/BlueROCKER® SoftKIT™ - Black	
Size	Product Code
Extra Small/Small	283960011
Medium/Large/Extra Large	283960013



Allard SoftKIT™

- Essential padding system for use with ToeOFF® and BlueROCKER® AFOs as a soft interface between the orthosis and tibia crest
- Includes two narrow neoprene pads, pre-cut pressure sensitive MikroFIX™ tabs and a spare pad that can be worn whilst the other is laundered

SoftKIT™	
Size	Product Code
Extra Small	283900010
Small	283900011
Medium	283900012
Large/Extra Large	283900013



Allard ComfortKIT™ Available direct from Sheffield stock

- Premium interface for ToeOFF® and BlueROCKER® AFOs
- Ideal for wearers who require higher levels of cushioning, comfort and fit
- Includes two narrow neoprene pads, pre-cut pressure sensitive MikroFIX™ tabs and a spare pad that can be worn whilst the other is laundered

ComfortKIT™	
Size	Product Code
Extra Small	283980010
Small	283980011
Medium	283980012
Large/Extra Large	283980013



Promedics Lacer Ankle Brace Universal

- A low-profile, comfortable brace offering stability in a discreet, yet supportive design
- Features comfortable stays for stability
- Laced enclosure is easy to apply with figure of 8 strapping and elastic cuff



Lacer Ankle Brace

Size	Product Code	Ankle Circumference	Shoe Size (UK)
Extra Extra Small	LCRA/01	22cm - 25cm	3
Extra Small	LCRA/02	25cm - 28cm	4 - 6
Small	LCRA/03	28cm - 30cm	6.5 - 8
Medium	LCRA/05	30cm - 33cm	8.5 - 10
Large	LCRA/07	33cm - 35cm	10.5 - 12
Extra Large	LCRA/08	35cm - 38cm	12.5 - 14
Extra Extra Large	LCRA/09	38cm - 40cm	14+

Promedics Malleostromg

- Ankle brace for limiting pro- and supination
- Thin breath-o-prene structure with padded medial and lateral shells, plus additional rear padding for improved comfort
- Circular strap for limiting talar shift (can be shortened to fit)
- Functional therapy of 2nd degree distortions
- Functional recovery following 3rd degree distortions and consequences of malleolar fractures
- **Contains latex**



Malleostromg

Size	Product Code (Left)	Product Code (Right)	Shoe Size (UK)
Extra Small	M.A1028/XSL	M.A1028/XSR	1 - 3
Small	M.A1028/SL	M.A1028/SR	3 - 5
Medium	M.A1028/ML	M.A1028/MR	6 - 8
Large	M.A1028/LL	M.A1028/LR	9 - 12
Extra Large	M.A1028/XLL	M.A1028/XLR	12 +

Promedics Anklet

- A pull-on Neoprene support for light compression and ankle support



Anklet

Size	Product Code	Shoe Size (UK)
Small	ANK/03	3 - 5
Medium	ANK/05	5 - 7
Large	ANK/07	7 - 9
Extra Large	ANK/08	9 - 11

Ossur Form Fit® Ankle With Figure 8 Available direct from Sheffield stock

- Inversion/eversion control
- Figure 8 strap adds even greater level of support
- Low profile
- Close fitting
- Quick lace up design
- Breathable material

Ossur Form Fit Ankle With Figure 8

Size	Product Code	Ankle Circumference*
Extra Small	B-212000001	28 - 30.5cm
Small	B-212000002	30.5 - 33cm
Medium	B-212000003	33 - 35.5cm
Large	B-212000004	35.5 - 38cm
Extra Large	B-212000005	38 - 40.5cm

*Measure ankle circumference diagonally over the base of the heel and across the ankle bone.



Promedics Push Aequi Ankle Brace Available direct from Sheffield stock

- Balances efficient ankle support and good wearer comfort
- Features rigid support on the medial side with a recess for the malleolus
- Preformed foam lateral side, which adapts to the individual anatomy
- Fastened by means of a diagonal strap and elastic straps apply pressure around the ankle
- Inversion/eversion movement of the ankle is restricted whilst plantar dorsal flexion is uninhibited during normal walking and running
- Optimal stabilisation achieved when worn with a closed (laced-up) shoe

Push Aequi Ankle Brace

Size	Product Code Left	Product Code Right	Ankle Circumference
1	320111	320121	270 - 310mm
2	320112	320122	310 - 340mm
3	320113	320123	340 - 400mm



Thuasne Malleo Dynastab BOA Ankle Brace Available direct from Sheffield stock

- Premium ankle brace offering a high level of support whilst still being light weight
- Low profile, can be worn in any type of shoe
- Boa lacing system enables quick and easy fitting
- Micro-aerated 3D fabric
- Additional straps

Malleo Dynastab BOA Ankle Brace

Size	Product Code	Circumference of Leg Above Ankle
0	23510220000199	16 - 19cm
1	23510220100199	19 - 22cm
2	23510220200199	22 - 26cm
3	23510220300199	26 - 30cm



Thuasne Silistab Anchillo® Ankle Brace

- Designed for treating Achilles tendon disorders
- Tendon protection
- Anatomically-shaped knit
- Massage effect
- Soft silicone heel pieces

Thuasne Silistab Anchillo® Ankle Brace

Size	Product Code	Circumference of Leg Above Ankle
1	23550320100199	19 - 21cm
2	23550320200199	21 - 23cm
3	23550320300199	23 - 25cm
4	23550320400199	25 - 27cm
5	23550320500199	27 - 30cm



Thuasne Malleoaction® Ankle Brace

- Provides support and proprioception for people with a moderate activity level
- Anatomically-shaped weave
- Patented pull tabs

Thuasne Malleoaction® Ankle Brace

Size	Product Code	Circumference of Leg Above Ankle
1	23610320000199	19 - 21cm
2	23610320100199	21 - 23cm
3	23610320200199	23 - 25cm
4	23610320300199	25 - 27cm
5	23610320400199	27 - 30cm



Thuasne Silistab® Malleo Ankle Support

- Protects the malleoli and supports the instep
- Anatomically-shaped weave
- Silicone insert

Thuasne Silistab® Malleo Ankle Support

Size	Product Code	Circumference of Leg Above Ankle
1	23650120100399	19 - 20cm
2	23650120200399	21 - 22cm
3	23650120300399	23 - 24cm
4	23650120400399	25 - 27cm
5	23650120500399	28 - 30cm
6	23650120600399	31 - 33cm



Thuasne Malleo Dynastab® Vario

- Combines firm base material with a rigid plastic element and crossover strap to immobilise and stabilise the upper and lower ankle joints
- Pronation, supination and plantar flexion are restricted; talus prolapse is counteracted
- Modular design is variable to match the different stages of the therapy process

Thuasne Malleo Dynastab® Vario

Size	Product Code	Circumference of Leg Above Ankle
1	T47973220101199	19 - 22cm
2	T47973220201199	22 - 26cm
3	T47973220301199	26 - 30cm



Thuasne Ligastrap® Malleo Ankle Brace

- Provides reinforcement of the lateral ligaments
- Compressive knit 27.5 mmHg
- Anti-slip system
- Double strapping
- Additional strap

Thuasne Ligastrap® Malleo Ankle Brace

Size	Product Code	Circumference of Leg Above Ankle
1	21800420100199	19 - 21cm
2	21800420200199	21 - 23cm
3	21800420300199	23 - 25cm
4	21800420400199	25 - 27cm
5	21800420500199	27 - 30cm



Medi Levamed®

- Ankle support for soft tissue compression
- 3D silicone pad - pleasantly thin for high wearing comfort
- Comfort Zone in the sensitive instep region
- High level of breathability on the sole

MalleoTrain® S - Silver

Size	Product Code	Circumference of Leg Above Ankle
I	509/I	17 - 20cm
II	509/II	20 - 22cm
III	509/III	22 - 23cm
IV	509/IV	24 - 26cm
V	509/V	26 - 28cm
VI	509/VI	28 - 30cm



Medi Achimed®

- Support for soft tissue compression of the Achilles tendon
- Innovative comfort-knit with anatomically correct fit
- 3D silicone pad
- Wedges to raise the heel are included

Medi Achimed® - Silver

Size	Product Code	Circumference of Leg Above Ankle
I	512/I	17 - 20cm
II	512/II	20 - 22cm
III	512/III	22 - 23cm
IV	512/IV	24 - 26cm
V	512/V	26 - 28cm
VI	512/VI	28 - 30cm



Beagle Neurodyn Foot Lift Ankle Brace Available direct from Sheffield stock

- Fabric orthosis for dynamic compensation of flaccid paralysis
- Dynamics instead of rigid splints - comfort instead of pressure
- Latex free
- Free plantar flexion
- Two straps on the forefoot encourage dorsi-flexion and inversion to give a more normal gait
- Available in black or beige

Neurodyn Foot Lift Ankle Brace

Size	Product Code Left (Black)	Product Code Right (Black)	Product Code Left (Beige)	Product Code Right (Beige)	Circumference of Leg Above Ankle
1	070771/L	070771/R	070771/L/BG	070771/R/BG	Up to 190mm
2	070772/L	070772/R	070772/L/BG	070772/R/BG	190 - 210mm
3	070773/L	070773/R	070773/L/BG	070773/R/BG	210 - 230mm
4	070774/L	070774/R	070774/L/BG	070774/R/BG	230 - 250mm
5	070775/L	070775/R	070775/L/BG	070775/R/BG	250 - 270mm



Beagle Neurodyn Comfort Ankle Brace

- Helps lift the foot up during gait
- Dynamic heel-to-toe roll behaviour
- Reduces danger of tipping
- Joint clasp enabling one hand fastening
- Flexible thermoplastic insole
- Cross over semi-elastic restraints with a strong lifting effect
- Comfortable ankle padding

Neurodyn Comfort Ankle Brace

Size	Product Code Left	Product Code Right	Above Ankle Circumference (mm)	Shoe Size (UK)
1	07830/1L	07830/1R	S < 210	3.5 - 4.5
2	07830/2L	07830/2R	S < 210	5 - 6
3	07830/3L	07830/3R	S < 210	7 - 7.5
4	07830/4L	07830/4R	S < 210	8 - 9
5	07830/5L	07830/5R	S < 210	9.5 - 10.5
6	07830/6L	07830/6R	S < 210	11 - 12
7	07830/7L	07830/7R	M 210 - 240	3.5 - 4.5
8	07830/8L	07830/8R	M 210 - 240	5 - 6
9	07830/9L	07830/9R	M 210 - 240	7 - 7.5
10	07830/10L	07830/10R	M 210 - 240	8
11	07830/11L	07830/11R	M 210 - 240	9.5 - 10.5
12	07830/12L	07830/12R	M 210 - 240	11 - 12
13	07830/13L	07830/13R	L > 240	3.5 - 4.5
14	07830/14L	07830/14R	L > 240	5 - 6
15	07830/15L	07830/15R	L > 240	7 - 7.5
16	07830/16L	07830/16R	L > 240	8 - 9
17	07830/17L	07830/17R	L > 240	9.5 - 10.5
18	07830/18L	07830/18R	L > 240	11 - 12



Ossur Exoform Dorsal Night Splint

- Adjustable aluminum stay inside dorsal shell allows modification in the angle of dorsiflexion
- Soft, overmolded edges enhance comfort
- Hinged shell at the calf area prevents brace rotation
- Semi-rigid plantar pad reduces discomfort along the sides of the foot while providing an improved angle of dorsiflexion
- Non-slip surface on plantar pad prevents slipping during normal walking
- Circumferential heel and posterior strapping prevents migration while increasing overall comfort and effectiveness
- Strapping and shell perforations improve comfort and breathability



Exoform Dorsal Night Splint

Size	Product Code
Medium	W-50085
Large	W-50087

Brace Orthopaedic Artisan Ankle+

- Unique pliable aluminium construction allows a 'custom fit' from a stock item
- Custom fit promotes patient compliance and comfort
- Shaping does not require the use of a heat gun, water bath, or removal of stays
- Lightweight and slim line profile
- Ability to re-shape and change ROM as required
- ROM can be changed in all planes, including frontal
- Features ventilation holes and increased padding
- Supplied with multiple straps



Artisan Ankle+

Size	Measurement	Product Code	Left/Right
Small	Shoe Size 2 - 5.5	55020	Universal
Medium	Shoe Size 5.5 - 9	55021	Universal
Large	Shoe Size > 9	55022	Universal

Also available in paediatric sizing, see page 152.

Promedics Air/Gel Ankle

- Features two plastic medial and lateral ankle supports, lined with closed-cell foam and shaped to fit comfortably over the malleoli
- Two detachable air/gel bags line the splint and can be used for hot or cold therapy
- Plastic supports attach to a 'stirrup' of closed cell foam, fixed with a hook and loop fastening, worn under the heel.
- One size; universal design fits left and right



Air/Gel Ankle

Size	Product Code
Universal	AGA/10

Promedics FixStep Walker

- Excellent rocker sole profile for improved gait
- Two-part injection moulded sole unit
- Improved shock absorbing - less impact during walking
- Flared and deeper heel section to retain foot and reduce any pressure on Achilles area
- High quality hook/loop straps - easy for patients to open
- Strap lock system avoids straps rotating
- Moulded high volume pump on air liner for faster inflation and easier patient use
- Comfortable detachable liners with replacements available
- Reinforced moulded plastic uprights - metal free - making them x-ray safe



Promedics FixStep Walker

Size	Product Code	Shoe Size (UK)
Extra Small	FXP/02	1.5 - 3
Small	FXP/03	3 - 5.5
Medium	FXP/05	6 - 9
Large	FXP/07	9.5 - 11
Extra Large	FXP/08	11 - 13.5



Promedics FixStep Walker with Air

Size	Product Code	Shoe Size (UK)
Extra Small	FXPA/02	1.5 - 3
Small	FXPA/03	3 - 5.5
Medium	FXPA/05	6 - 9
Large	FXPA/07	9.5 - 11
Extra Large	FXPA/08	11 - 13.5

Promedics FixStep Walker Short

Size	Product Code	Shoe Size (UK)
Extra Small	FXPS/02	1.5 - 3
Small	FXPS/03	3 - 5.5
Medium	FXPS/05	6 - 9
Large	FXPS/07	9.5 - 11
Extra Large	FXPS/08	11 - 13.5

Promedics FixStep Walker Short with Air

Size	Product Code	Shoe Size (UK)
Extra Small	FXPSA/02	1.5 - 3
Small	FXPSA/03	3 - 5.5
Medium	FXPSA/05	6 - 9
Large	FXPSA/07	9.5 - 11
Extra Large	FXPSA/08	11 - 13.5

Promedics Airstep™ Walker

- Airstep™ is an innovative walker with a fully integrated inflation system that allows independent adjustment
- Super lightweight - ventilated shell system
- Breathable fitted contoured liner
- Low profile sole unit - minimal height discrepancy
- Easy three strap closure
- Fast and easy to fit
- No separate pump required
- Excellent stability
- Achilles wedges available

Airstep™ Walker - Tall

Size	Product Code	Shoe Size (UK)
Extra Small	ASW/02	1.5 - 3
Small	ASW/03	3 - 5.5
Medium	ASW/05	6 - 9
Large	ASW/07	9.5 - 11
Extra Large	ASW/08	11 +

Airstep™ Walker - Short

Size	Product Code	Shoe Size (UK)
Extra Small	ASSW/02	1.5 - 3
Small	ASSW/03	3 - 5.5
Medium	ASSW/05	6 - 9
Large	ASSW/07	9.5 - 11
Extra Large	ASSW/08	11 +



Dual integrated pumps for fast, easy inflation



Low profile, hard wearing sole unit
Improved gait function



Short version



Adjustable/removable toe guard



Promedics Air Shield Walker

- Available with charcoal or red liners
- Lightweight low profile walker, allows for good gait pattern
- Independently adjustable dual airbags
- Features a comfortable breathable liner with toe cover
- Anterior and posterior shells offer improved stability and immobilisation with velour strap fastening
- Removeable shells for staged rehabilitation



Dual airbags - independently adjustable



Air Shield Walker - Charcoal

Size	Product Code	Shoe Size (UK)
Small	JWA/03/C	3 - 5.5
Medium	JWA/05/C	6 - 9
Large	JWA/07/C	9.5 - 11
Extra Large	JWA/08/C	11 +

Promedics Achilles Wedges

- Extension straps included

Achilles Wedges

Left	Right
JWW/RL	JWW/RR



Promedics Air Shield Walker - Short

- Only available with charcoal liners

Size	Product Code	Shoe Size (UK)
Small	JWAS/03/C	3 - 5.5
Medium	JWAS/05/C	6 - 9
Large	JWAS/07/C	9.5 - 11
Extra Large	JWAS/08/C	11 +



Promedics Traverse Air Walker

- Circumferential walking boot that utilises dual air pumps for targeted, comfortable compression
- Available in both Tall and Short versions
- Comfortable and lightweight
- Easy to apply and remove
- Air pump pressure can be controlled from either side of the ankle
- Rocker base promotes a natural and stable gait
- Shock absorbing heel design

Promedics Traverse Air Walker - Tall

Size	Product Code	Mens Shoe Size (UK)	Ladies Shoe Size (UK)
Extra Small	653011	Up to 3.5	Up to 4.5
Small	653012	3.5 - 6.5	2.5 - 5.5
Medium	653013	6.5 - 9	5.5 - 8
Large	653014	9 - 11	8 - 10
Extra Large	653015	11 - 14.5	10 - 13.5

Promedics Traverse Air Walker - Short

Size	Product Code	Mens Shoe Size (UK)	Ladies Shoe Size (UK)
Extra Small	653001	Up to 3.5	Up to 4.5
Small	653002	3.5 - 6.5	2.5 - 5.5
Medium	653003	6.5 - 9	5.5 - 8
Large	653004	9 - 11	8 - 10
Extra Large	653005	11 - 14.5	10 - 13.5

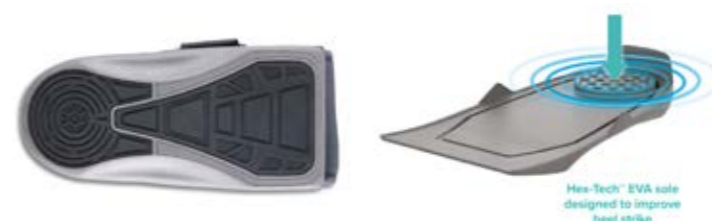

Ossur Formfit® Walker

- Patented pneumatic system is designed to increase stability while decreasing pain and swelling. The intuitive pump and clearly marked decompression valve make air/pressure adjustments easy
- High and low top versions available
- Low, wide rocker bottom promotes a stable, natural gait
- Shock absorbing sole for reduced impact at heel strike
- Breathable, seamless liner

Ossur Formfit® Walker

Size	Product Code - Standard	Product Code - Low	Shoe Size (UK) - Mens	Shoe Size (UK) - Ladies
Extra Small	W0200BLK	W0300BLK	2 - 4	3.5 - 5.5
Small	W0400BLK	W0500BLK	4.5 - 7	6 - 8
Medium	W0600BLK	W0700BLK	7.5 - 10.5	8.5 - 11.5
Large	W0800BLK	W0900BLK	10.5 - 12.5	11.5 - 13.5
Extra Large	W1000BLK	W1100BLK	12.5+	13.5+



Ossur Formfit® Air Walker

Size	Product Code - Standard	Product Code - Low	Shoe Size (UK) - Mens	Shoe Size (UK) - Ladies
Extra Small	A-W0200BLK	A-W0300BLK	2 - 4	3.5 - 5.5
Small	A-W0400BLK	A-W0500BLK	4.5 - 7	6 - 8
Medium	A-W0600BLK	A-W0700BLK	7.5 - 10.5	8.5 - 11.5
Large	A-W0800BLK	A-W0900BLK	10.5 - 12.5	11.5 - 13.5
Extra Large	A-W1000BLK	A-W1100BLK	12.5+	13.5+



Promedics ROM Walker

- Lightweight ROM walker
- Features detachable foam liners and return-loop hook and loop fastening.
- Fully moulded plastic foot section with rubber sole and padded insole
- Easily adjustable 'Push-Dial-Set' range of motion settings
- Settings can be 'locked' in by addition of tie wrap through flexion/extension controls
 - Plantarflexion Settings: 0, 10, 30, 45 degrees
 - Dorsiflexion Settings: 0, 10, 30 degrees

Size	Product Code	Shoe Size (UK)
Small	JWR/03	3 - 5.5
Medium	JWR/05	6 - 9
Large	JWR/07	9.5 - 11
Extra Large	JWR/08	11+





Knee Braces

Thuasne Unireliever

- Consolidated cross strapping system with buttress designed to alleviate OA through evenload disbursement
- Thuasne motion hinge technology with range of motion control
- Flexible open cuffs for a comfortable and breathable fit
- Antimicrobial and anti-migration padding with non-slip silicone webbing
- Formable uprights and trimmable straps
- BOA® fit system for precise force adjustment
- Universal sizing, left or right

Thuasne Unireliever

Description	Product Code
Unireliever L.Med/R.Lateral V2	U3090129900351
Unireliever R.Med/L.Lateral V2	U3090129900352



Thuasne Action Reliever

- Semi-soft OA knee brace
- Dynamic off-loading provided by the straps and the combined rigid adjustable hinge on the affected side/flexible stay on the unaffected side
- The Action Reliever has a unique off-loading action utilising straps to create a dynamic 3-point pressure system that is most effective on heel strike
- Invisible under most clothes
- Anatomical knit with integrated anti-slip silicone, comfort zone at popliteal crease and stretch knit at the edges
- Easy to close thanks to the effortless magnetic buckles with finger loop
- Two models available for both medial or lateral OA: right medial/left lateral and left medial/right lateral

Thuasne Action Reliever

Size	Product Code (Left Medial/Right Lateral)	Product Code (Right Medial/Left Lateral)	Thigh Circ.	Knee Circ.	Calf Circ.
S1	23490120100151	23490120100152	38 - 41cm	32 - 34cm	28 - 31cm
S2	23490120200151	23490120200152	42 - 45cm	35 - 37cm	32 - 35cm
S3	23490120300151	23490120300152	45 - 48cm	38 - 41cm	35 - 38cm
S4	23490120400151	23490120400152	48 - 51cm	42 - 45cm	39 - 42cm
S5	23490120500151	23490120500152	50 - 53cm	46 - 49cm	41 - 44cm
S6	23490120600151	23490120600152	53 - 56cm	50 - 53cm	44 - 47cm
S7	23490120700151	23490120700152	56 - 61cm	53 - 56cm	48 - 51cm
S8	23490120800151	23490120800152	61 - 66cm	56 - 59cm	51 - 54cm



Thuasne Genu Ligaflex® ROM Open

- Ligament stabilisation: 2 rigid aluminium uprights with TM5+ hinge that reproduces the natural movement of the knee* and 4 staggered half-straps
- Motion control: adjustment of extension (from 0° to 40°) and flexion (from 0° to 90°) with a tool-less system
- Compression and proprioceptive effect: due to compressive elastic knit
- Comfort: anatomically-shaped extensible knit with comfort zones over the patella and at the popliteal area
- Hold: silicone-coated threads at top edge of brace
- Ease of application: totally open product, markers on the straps, clip buckle system

Thuasne Genu Ligaflex® ROM Open

Size	Product Code - Left	Knee Circumference
1	23860520100102	32 - 34cm
2	23860520200102	35 - 37cm
3	23860520300102	38 - 41cm
4	23860520400102	42 - 45 cm
5	23860520500102	46 - 49cm
6	23860520600102	50 - 53cm



Thuasne Rebel® Reliever Knee Brace

- Knee offloading: adjustable 3-point leverage system (Load-shifter technology) with up to 9° in varus or valgus
- Clinically proven efficacy
- Ligament stabilisation: rigid frame with TM5+ hinge that reproduces the natural movement of the knee
- Motion control: adjustment of extension (from 0° to 40°) and flexion (from 0° to 90°) with a tool-less system
- Hold: synergistic suspension strap, tibia bolster to avoid rotation, C/S (Compression/Suspension) package to enhance support by preventing slipping
- Comfort: interior padding and condylar pads in foam
- Ease of application: buckles and tool-less offloading setting (Snap Lock).



Thuasne Rebel® Reliever Knee Brace

Size	Product Code - Left	Product Code - Right	Thigh Circ.	Knee Width	Calf Circ.
Extra Small	U0330920106602	U0330920106601	31 - 39cm	7.5 - 9cm	28 - 32cm
Small	U0330920206602	U0330920206601	39 - 47cm	9 - 10cm	31 - 35cm
Medium	U0330920306602	U0330920306601	47 - 53cm	10 - 11.5cm	34 - 38cm
Large	U0330920406602	U0330920406601	53 - 60cm	11.5 - 12.5cm	37 - 40cm
Extra Large	U0330920506602	U0330920506601	60 - 64cm	12.5 - 14cm	38 - 43cm
Extra Extra Large	U0330920606602	U0330920606601	64 - 71cm	14 - 15.5cm	43 - 48cm

Thigh circumference: 15cm above mid-patella.
Calf circumference: 15cm below mid-patella.

Thuasne Rebel® Pro Knee Brace

- Contoured aircraft aluminium frame
- Held in place by the TM5+ articulation reproducing the natural movement of the knee and the suspension strap
- Synergistic suspension strap
- Compression/suspension package
- Adjustable nonelastic straps
- Strap pads with anti-migration silicone
- Gloss gray powder coat finish
- Extension stop kit for limiting hinge motion



Thuasne Rebel® Pro Knee Brace

Size	Product Code - Left	Product Code - Right	Thigh Circ.	Knee Width	Calf Circ.
Extra Small	U0310220106502	U0310220106501	31 - 39cm	7.5 - 9cm	28 - 32cm
Small	U0310220206502	U0310220206501	39 - 47cm	9 - 10cm	31 - 35cm
Medium	U0310220306502	U0310220306501	47 - 53cm	10 - 11.5cm	34 - 38cm
Large	U0310220406502	U0310220406501	53 - 60cm	11.5 - 12.5cm	37 - 40cm
Extra Large	U0310220506502	U0310220506501	60 - 64cm	12.5 - 14cm	38 - 43cm

Thigh circumference: 15cm above mid-patella.
Calf circumference: 15cm below mid-patella.

Thuasne Rebel® Standard Ligament Knee Brace

- Ligament stabilisation: prevention of abnormal translation and rotation movements of the tibia (aluminium rigid frame, anterior tibial bolster shell and TM5+ hinge that reproduces the natural movement of the knee*)
- Suspension on the leg: suspension strap, tibia bolster to avoid rotation
- Motion control: adjustment of extension (from 0° to 30°) and flexion (from 0° to 110°)
- Comfort: interior padding and condylar pads in foam
- Short product (33 cm)
- Medium stiffness aluminium frame



Thuasne Rebel® Standard Ligament Knee Brace

Size	Product Code - Left	Product Code - Right	Knee Width
Extra Small	U0340120100502	U0340120100501	8 - 9cm
Small	U0340120200502	U0340120200501	9 - 10cm
Medium	U0340120300502	U0340120300501	10 - 11.5cm
Large	U0340120400502	U0340120400501	11.5 - 13cm
Extra Large	U0340120500502	U0340120500501	13 - 14cm

Thuasne Rebel® Lock Knee Brace

- Ligament stabilisation: rigid frame with a 4-point stabilisation system and TM5+ hinge that reproduces the natural movement of the knee.
- Locking mechanism: drop locks for an extension lock (0° and 5°) and a flexion lock (30°, 60° and 90°) with simple pressure
- Suspension on the leg: suspension strap, tibia bolster to avoid rotation, C/S (Compression/Suspension) package to enhance support by preventing slipping
- Comfort: interior padding and condylar pads in foam



Thuasne Rebel® Lock Knee Brace

Size	Product Code - Left	Product Code - Right	Knee Width
Extra Small	U3020220106602	U3020220106601	8 - 9cm
Small	U3020220206602	U3020220206601	9 - 10cm
Medium	U3020220306602	U3020220306601	10 - 11.5cm
Large	U3020220406602	U3020220406601	11.5 - 13cm
Extra Large	U3020220506602	U3020220506601	13 - 14cm

Allard CROSS™ Knee Brace

- Semi-rigid knee orthosis, designed to function together with an Allard AFO
- Easy to don and doff with one hand
- Strategically placed silicone band to prevent migration
- Reinforcement in the upper wide cuff keeps the orthosis open so the foot and leg slide easily into the brace - aids users with limited function
- Adjustable ROM stops - flexion: 45, 60, 75, 90 degrees and extension: 0, 10, 20, 30, 40 degrees

Allard Cross™ Knee Brace

Size	Product Code	Measure 1	Measure 2	Measure 3
Small	287150011	32 - 37	32 - 37	39 - 44
Medium	287150012	36 - 41	36 - 41	43 - 48
Large	287150013	40 - 45	40 - 45	47 - 52
Extra Large	287150014	44 - 49	44 - 49	51 - 57

Measure 1: 15 cm below patella. Measure 2: Mid-patella. Measure 3: 15 cm above patella.



Ossur Unloader One®

Unloader One® is designed to relieve osteoarthritis knee pain and wearing it may help improve mobility. It features Ossur's unique, patented 3-point leverage system, which combines a single hinge with dual Dynamic Force System (DFS) straps to provide unloading of the knee joint. Clinical studies demonstrate that this system may relieve osteoarthritis knee pain and improve function and quality of life while being worn. Colour-coded Quick Fit buckles make donning and doffing simple, while flexible shells and breathable liners are designed to improve comfort and reduce migration, thus helping to ensure compliance.

- Dual Dynamic Force Straps® designed to reduce pressure on sensitive bony surfaces of the knee, resulting in reduction of pain
- Lightweight frame, perforated for flexibility and ventilation, with flexible, low profile upright that contours to patient anatomy and allows use underneath clothing
- Tool-free SmartDosing® dial enables fine-tuned pain management and can be adjusted even when wearing the brace under clothing
- Colour-coded quick fit buckles enable easy application and removal
- Proprietary Sensi® silicone liners designed to reduce migration
- Available in standard and short version, for a perfect fit on shorter legs



Unloader One®

Unloader One® with SmartDosing

Description	Size	Calf Circumference	Product Code Left Medial	Product Code Right Medial	Product Code Left Lateral	Product Code Right Lateral
Unloader One® with SmartDosing	S	31 - 35.5cm	B-240618712	B-240518712	B-240628712	B-240528712
Unloader One® with SmartDosing	M	35.5 - 42.5cm	B-240618713	B-240518713	B-240628713	B-240528713
Unloader One® with SmartDosing	L	42.5 - 51cm	B-240618714	B-240518714	B-240628714	B-240528714
Unloader One® with SmartDosing	XL	51 - 61.5cm	B-240618715	B-240518715	B-240628715	B-240528715
Unloader One® Short with SmartDosing	XS	25 - 31cm	B-241618711	B-241518711	B-241628711	B-241528711
Unloader One® Short with SmartDosing	S	31 - 35.5cm	B-241618712	B-241518712	B-241628712	B-241528712
Unloader One® Short with SmartDosing	M	35.5 - 42.5cm	B-241618713	B-241518713	B-241628713	B-241528713
Unloader One® Short with SmartDosing	L	42.5 - 51cm	B-241618714	B-241518714	B-241628714	B-241528714
Unloader One® Short with SmartDosing	XL	51 - 61.5cm	B-241618715	B-241518715	B-241628715	B-241528715
Unloader One® with Ratchet	S	31 - 35.5cm	B-240619712	B-240519712	B-240629712	B-240529712
Unloader One® with Ratchet	M	35.5 - 42.5cm	B-240619713	B-240519713	B-240629713	B-240529713
Unloader One® with Ratchet	L	42.5 - 51cm	B-240619714	B-240519714	B-240629714	B-240529714
Unloader One® with Ratchet	XL	51 - 61.5cm	B-240619715	B-240519715	B-240629715	B-240529715
Unloader One® Short with Ratchet	XS	25 - 31cm	B-241619711	B-241519711	B-241629711	B-241529711
Unloader One® Short with Ratchet	S	31 - 35.5cm	B-241619712	B-241519712	B-241629712	B-241529712
Unloader One® Short with Ratchet	M	35.5 - 42.5cm	B-241619713	B-241519713	B-241629713	B-241529713
Unloader One® Short with Ratchet	L	42.5 - 51cm	B-241619714	B-241519714	B-241629714	B-241529714
Unloader One® Short with Ratchet	XL	51 - 61.5cm	B-241619715	B-241519715	B-241629715	B-241529715

Standard version is recommended for patients above 1.65m. Short version is recommended for patients under 1.65m tall. Hinge is placed on the side of the affected compartment

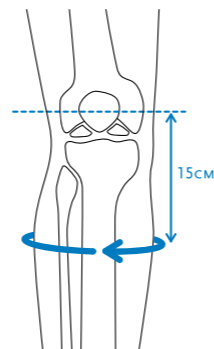

Circumference measurement: 15cm below mid-patella.

Ossur Unloader One Plus®

Many sufferers of OA knee pain are overweight. For these patients, containing excess soft tissue is essential for comfortable and effective bracing. That's why our new Unloader One Plus® model features a wider thigh strap than the standard version, plus a gastroc strap that helps secure the brace in place. And because bigger legs require more support, we included a sturdier upright with an Adjustable Dynamic Joint, enabling additional leverage for optimal pain management. Multiple, peer-reviewed clinical and biomechanical studies have proven the efficacy of this technology.



- 3-Point Leverage System provides clinically relevant pain relief of affected compartment
- Single SmartDosing dial allows fine-tuned pain management
- Helps keep patients mobile during daily activities
- Discreet hinge and sleeve design ensure a snug fit underneath clothing
- Lightweight and easy to use

Description	Size	Thigh Circ.	Calf Circ.	Product Code Left Medial	Product Code Right Medial	Product Code Left Lateral	Product Code Right Lateral
Unloader One Plus® with Ratchet	L	53 - 64cm	36 - 43cm	B-245610004	B-245510004	B-245620004	B-245520004
Unloader One Plus® with Ratchet	XL	64 - 81cm	43 - 51cm	B-245610005	B-245510005	B-245620005	B-245520005

Standard version is recommended for patients between 1.65 and 1.92 metres tall.

Ossur Unloader One® X

Unloader One X improves mobility by providing pain relief from knee osteoarthritis and degenerative meniscal tears.

- 3-Point Leverage System consisting of two Dynamic Force System (DFS) Straps, rigid shells and a single upright hinge contribute to a unicompartmental unloading of the knee joint
- Unloading effective only when needed, no condyle pressure during sitting or swing phase
- Slender, perforated frame with soft edges, which contours easily and remains discreet
- Skin-friendly liners, pads and smooth inner surface reduce likelihood of pressure points
- Gastroc strap is positioned over the thickest part of calf to help prevent slippin.
- Tool-free SmartDosing® dials enable the patient to be in control of their pain level by fine-tuning the strap tension
- Colour coded touchpoints and Quick-Fit buckles make it easy to use
- Alignment guide on hinge facilitates correct positioning on the leg
- Entire brace is machine washable (washbag included with product)



Description	Size	Product Code Left Medial	Product Code Right Medial	Product Code Left Lateral	Product Code Right Lateral
Ossur Unloader One® X Short	XS - M	UOX1618713	UOX1518713	UOX1628713	UOX1528713
Ossur Unloader One® X Short	L - XL	UOX1618715	UOX1518715	UOX1628715	UOX1528715
Ossur Unloader One® X Standard	XS - M	UOX0618713	UOX0518713	UOX0628713	UOX0528713
Ossur Unloader One® X Standard	L - XL	UOX0618715	UOX0518715	UOX0628715	UOX0528715

Short recommended for patients with an inseam measurement < 85cm. Standard recommended for patients with an inseam measurement > 85cm. Hinge is placed on the side of the affected compartment.

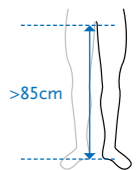
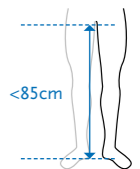

Medi M.4®s Comfort CI

- 4-point knee brace with flexion/extension limitation
- Pain reduction and recovery of the mobility
- Secure fit due to physioglide hinge
- Divided strap cushions for unwanted pressure
- Available in Standard or Short

Medi M.4®s Comfort CI - Standard

Size	Product Code - Left	Product Code - Right	Thigh Circumference
XS	801/C/1	800/C/1	31 - 37cm
S	801/C/2	800/C/2	37 - 45cm
M	801/C/3	800/C/3	45 - 51cm
L	801/C/4	800/C/4	51 - 57cm
XL	801/C/5	800/C/5	57 - 65cm
XXL	801/C/6	800/C/6	65 - 74cm

Medi M.4®s Comfort CI - Short

Size	Product Code - Left	Product Code - Right	Thigh Circumference
XS	809S/1	808S/1	31 - 37cm
S	809S/2	808S/2	37 - 45cm
M	809S/3	808S/3	45 - 51cm
L	809S/4	808S/4	51 - 57cm
XL	809S/5	808S/5	57 - 65cm
XXL	809S/6	808S/6	65 - 74cm



Promedics OA Wrap

- Premium knee wrap
- Ideal for patients with mild-to moderate Osteoarthritis
- Breathable, high compression material
- Patient friendly closure tabs for easy application

Promedics OA Wrap

Size	Product Code (Left Medial)	Product Code (Right Medial)	Thigh	Knee	Calf
Small	PROAP/13	PROAP/23	39 - 47cm	33 - 35cm	30.5 - 35.5cm
Medium	PROAP/15	PROAP/25	47 - 53.5cm	35.5 - 38cm	35.5 - 40.5cm
Large	PROAP/17	PROAP/27	53.5 - 59.5cm	38 - 43cm	40.5 - 47cm
Extra Large	PROAP/18	PROAP/28	59.5 - 67.5cm	43 - 48.5cm	47 - 50.5cm

*For lateral OA, use corresponding left code on the right leg and corresponding right code on the left leg.



Medi M.4®s OA Comfort

- 4-point knee brace for varus or valgus pressure relief and stabilisation
- Pain reduction and recovery of mobility
- Light weight frame and hinge construction
- Reliable relief of the affected compartment

Medi M.4®s OA Comfort

Size	Product Code - Right Varus	Product Code - Left Varus	Product Code - Right Valgus	Product Code - Left Valgus	Thigh Circumference
XS	904/1	905/1	906/1	907/1	31 - 37cm
S	904/2	905/2	906/2	907/2	37 - 45cm
M	904/3	905/3	906/3	907/3	45 - 51cm
L	904/4	905/4	906/4	907/4	51 - 57cm
XL	904/5	905/5	906/5	907/5	57 - 65cm
XXL	904/6	905/6	906/6	907/6	65 - 74cm



Aspen OA+ Knee Brace Available direct from Sheffield stock

- Premium knee brace
- Ideal for patients with mild-to moderate Osteoarthritis
- Low profile, universal design allows for less inventory and better patient compliance

Aspen OA+ Knee Brace

Product Code (Left Medial)	Product Code (Right Medial)	Thigh Measurement
651011	651012	Up to 76.2cm

*For lateral OA, use /L on the right leg and /R on the left leg.

Aspen OA+ Knee Brace Accessories

Product Code	Description
651111	Aspen Knee Suspension Wrap
651124	Extended Strap Set - x2 / 102cm - up to 112cm high
651125	Strap Accessory Kit
651126	Liner Accessory Kit (Left)
651127	Liner Accessory Kit (Right)
651128	Extension/Flexion Stop Frame Kit
651129	Varus/Valgus Adjustment Key
651130	Aspen Quick Release Buckle Kit



Comfort
Comfortable, non-slip pads to help prevent migration.

Range Of Motion
Adjustable stops allow you to set the range of motion for appropriate treatment during continuum of care

Two Point Hinge Adjustment
Hinge adjustment for even pressure distribution and comfort.

One-Step Closure
Proprietary one-step closure system for easy donning and doffing.

Aspen Ci Knee Brace

- Easy application and removal - proprietary one-step closure system for easy donning and doffing
- Dual strut design provides increased stability
- Advanced aerospace grade aluminium provides stability and support for ligament issues such as ACL, PCL and combined instabilities
- Flexion/extension adjustments easily control the allowed range of motion

Aspen Ci Knee Brace

Size	Product Code Left	Product Code Right	Thigh Length	Calf Length
Small	652001	652006	39 - 47cm	30.5 - 35.5cm
Medium	652002	652007	47 - 53.25cm	35.5 - 40.5cm
Large	652003	652008	53.25 - 59.5cm	40.5 - 47cm
Extra Large	652004	652009	59.5 - 67.25cm	47 - 50.75cm

Aspen Ci Knee Brace Accessories

Product Code	Description
652120	Strap Accessory Kit - S
652121	Ci Knee, Strap Accessory Kit - M
652122	Ci Knee, Strap Accessory Kit - L
652123	Ci Knee, Strap Accessory Kit - XL
652125	Ci Knee, Liner Accessory Kit - S
652126	Ci Knee, Liner Accessory Kit - M
652127	Ci Knee, Liner Accessory Kit - L
652128	Ci Knee, Liner Accessory Kit - XL
652130	Ci Knee, Flexion/Extension Stop Frame
651130	Aspen Quick Release Buckle Kit



Easy Application & Removal
Proprietary one-step closure system for easy donning doffing.

Advanced Aerospace Grade Aluminium
Provides stability and support for ligament issues such as ACL, PCL and combined instabilities.

Dual Strut Design
Provides increased stability.

Flexion/Extension Adjustments
Easily control the allowed range of motion.



Promedics Ascender® Telescopic ROM Knee Brace

- Universal sizing
- Maximum strength, minimum weight
- High grade anodised aluminium
- Length range 44 cm - 70 cm
- 5 drop lock settings
- Quick-clip range of motion settings
- Available with foam pads

Promedics Ascender Telescopic ROM Knee Brace

Size	Product Code
Universal	ASC/10

Ascender Telescopic ROM Knee Brace with Foam Pads

Size	Product Code
Universal	ASCFP/10



Ossur Rebound® Post-op Available direct from Sheffield stock - Universal Cool Only

- Tool-free design and multi-purpose Smart-Fit™ packaging
- Available in universal, left or right contour and pediatric
- Telescoping frame from 47 - 69cm
- OneTouch™ easy to adjust ROM hinge with lock-out capability
- Color-coding and numbered frame for patient education
- Quick-fit, gripping buckles for easy application

Ossur Rebound® Post-op

Size	Thigh Circumference	Product Code Cool	Product Code Full Foam
Universal, Left contoured	41 - 81cm	B-8381680	B-8382680
Universal, Right contoured	41 - 81cm	B-8381580	B-8382580
Universal	41 - 81cm	B-8381480	B-8382480
Universal Extra Large	41 - 96.5cm	B-8381490	B-8382490

Circumference: 15cm above mid-patella.



Ossur Formfit® Post-op Knee Available direct from Sheffield stock - Cool Foam Only

- Breakaway struts for easy, tool free length adjustment
- OneTouch™ easy to adjust ROM hinge with lock-out capability from -10° to 30° (10° incremental)
- Extension control from -10° to 90° (10° incremental)
- Flexion control from 0° to 120° (10° incremental)
- Available in cool or foam models, 3 lengths, and two sizes (Regular and XL)

Ossur Rebound® Post-op

Size	Thigh Circumference	Product Code Cool Foam	Product Code Full Foam
Knee PO 24in DL	Up to 69cm	FPOK403100	FPOK403200
Knee PO XL 24in DL	69- 89cm	FPOK403102	FPOK403202
Knee PO 28in DL	Up to 69cm	FPOK403101	FPOK403201
Knee PO XL 28in DL	69- 89cm	FPOK403103	FPOK403203
Knee PO 16in DL	Up to 69cm	N/A	FPOK403300
Knee PO XL 16in DL	69 - 89cm	N/A	FPOK403301

Thigh circumference: 15cm above mid patella.





GENURANGE



Genurange hinges feature:

- A geared, polycentric hinge which mimics the action of the knee
- Four small pins which are inserted into apertures to set the hinge at the required angles of flexion and extension, between 10° and 110°
- A plastic hinge cover, with screw closure, to prevent patients tampering with the hinge mechanism
- Features plastic tags to prevent loss of pins

Promedics Genurange Universal

- To reduce stock-holding of different circumferences, the one size Universal wraps can be cut, without fraying, to fit most sizes
- Open-cell padding tibial and femoral liners are attached by four or six straps for an excellent fit
- Hinges, applied to the liners, align with the tibial condyles and the liners can be removed for replacement or laundering
- Available in four lengths
- Replacement wraps and straps available, see below



Genurange Universal			Replacement Liners and Straps	
Size	Product Code	Length	Size	Product Code
Small	GN/0510/18	45cm	Small	GNW/0510/18
Medium	GN/0510/20	50cm	Medium	GNW/0510/20
Large	GN/0510/22	55cm	Large	GNW/0510/22
Extra Large	GN/0510/24	60cm	Extra Large	GNW/0510/24

Promedics Genurehab

- The 40cm Genurehab is a short version of the Genurange Universal
- Designed for long term support and motion control during the more active phase of recovery
- The one-size Genurehab wraps can be cut without fraying, to fit most sizes
- To order replacement liners and straps, add 'W' after 'GN' in the code, e.g. GNW/0310



Genurehab	
Product Code	Size
GN/0310	Universal

Promedics Genuranger

- Towelling-lined tibial and femoral liners are attached by four straps; six straps on 61cm, for an excellent fit
- The hinges are applied to the liners to align with the tibial condyles, and the liners can be removed for replacement or laundering
- Available in five circumferences and five lengths
- Replacement wraps and straps available, see below



Genuranger,						
Size	40 cm	45 cm	50 cm	55cm	60 cm	Knee Circumference
Small	GN/0403/16	N/A	GN/0403/20	GN/0403/22	GN/0403/24	35 - 40cm
Medium	GN/0405/16	GN/0405/18	GN/0405/20	GN/0405/22	GN/0405/24	40 - 45cm
Large	GN/0407/16	GN/0407/18	GN/0407/20	GN/0407/22	GN/0407/24	45 - 50cm
Extra Large	GN/0408/16	GN/0408/18	GN/0408/20	GN/0408/22	GN/0408/24	55 - 60cm
Extra Extra Large	GN/0409/16	GN/0409/18	GN/0409/20	GN/0409/22	GN/0409/24	60 - 65cm

Promedics Genurange Lite

- A 'lite' wrap-around knee brace with ROM hinges
- 3D spacer fabric with open mesh posterior panel makes this a supportive, comfortable well fitting brace
- Suitable for the treatment various knee conditions including mild/moderate collateral ligament injuries and cruciate mild instability of the cruciate ligaments



Genurange Lite		
Size	Code	Circumference 15cm above mid-patella
Extra Small	GN/0802	32 - 38cm
Small	GN/0803	38 - 44cm
Medium	GN/0805	44 - 51cm
Large	GN/0807	51 - 58cm
Extra Large	GN/0808	58 - 66cm
Extra Extra Large	GN/0809	66 - 75cm

Thuasne Ligastrap® Genu

- Double strapping system with set-up marks and numbered, pre-oriented straps
- Proprioception provided by the compressive knit (about 26 mmHg)
- Anatomical knit with comfort zones over the kneecap and the back of the knee
- Easy to put on due to patented pull-on tabs



Thuasne Ligastrap® Genu

Size	Product Code	Knee Circumference
1	21700320100199	32 - 34cm
2	21700320200199	35 - 37cm
3	21700320300199	38 - 41cm
4	21700320400199	42 - 45cm
5	21700320500199	46 - 49cm
6	21700320600199	50 - 55cm

Thuasne Silistab® Genu

- Patella support: Y-shaped anatomical insert
- Proprioceptive effect due to compressive elastic knit* (compression: 15-20 mmHg /20.1-27 hPa)
- Support from flexible lateral stays with anti-slip improving hold
- Anatomically-shaped extensible knit with comfort zones
- Available in closed patella (black)
- Contains latex



Thuasne Silistab® Genu

Size	Product Code Closed Patella Black	Knee Circumference
1	23450420100399	31 - 33cm
2	23450420200399	34 - 36cm
3	23450420300399	37 - 39cm
4	23450420400399	40 - 42cm
5	23450420500399	43 - 45cm
6	23450420600399	46 - 48cm

Thuasne GenuExtrem

- Support and proprioception provided by the elastic compressive knit (approximately 28 mmHg)
- Additional lateral reinforcement provided by flexible stays
- Anatomically-shaped knit with comfort zones over the kneecap and behind the knee
- Easy to put on due to patented pull tabs
- Lateral silicone anti-slip system for better hold



Thuasne GenuExtrem

Size	Product Code	Knee Circumference
1	23210220100199	32 - 34cm
2	23210220200199	35 - 37cm
3	23210220300199	38 - 41cm
4	23210220400199	42 - 45cm
5	23210220500199	46 - 49cm
6	23210220600199	50 - 53cm

Thuasne PatellaReliever

- Half-moon insert and adjustable strap and lacing traction system for patella realignment
- 2 lateral hinged rigid uprights provide ligament stabilisation
- Support and proprioceptive effect: due to compressive elastic knit
- Anatomically-shaped extensible knit, with comfort zones
- Silicone-coated threads at top edge of brace
- Ease of application due to patented pull tabs
- Available in right or left leg model.



Thuasne PatellaReliever

Size	Product Code - Left	Product Code - Right	Knee Circumference
1	23480120100102	23480120100101	32 - 34cm
2	23480120200102	23480120200101	35 - 37cm
3	23480120300102	23480120300101	38 - 41cm
4	23480120400102	23480120400101	42 - 45cm
5	23480120500102	23480120500101	46 - 49cm
6	23480120600102	23480120600101	50 - 53cm

Thuasne GenuSoft

- Support and proprioception provided by the elastic compressive knit (compression: 15-20 mmHg /20.1-27 hPa)
- Anatomically-shaped extensible knit with comfort zones over the patella and at the popliteal area



Thuasne GenuSoft

Size	Product Code	Knee Circumference
1	23200320100199	32 - 34cm
2	23200320200199	35 - 37cm
3	23200320300199	38 - 41cm
4	23200320400199	42 - 45cm
5	23200320500199	46 - 49cm

Thuasne Genu Dynastab®

- 2 rigid uprights with biaxial hinges and 3 staggered half-straps provide ligament stabilisation
- Anatomical oval-shaped insert for patella support
- Compression and proprioceptive effect: due to compressive elastic knit
- Anatomically-shaped extensible knit with comfort zones over the patella and at the popliteal area
- Silicone-coated threads at top edge of brace
- Ease of application due to patented pull tabs



Thuasne Genu Dynastab®

Size	Product Code	Knee Circumference
1	23700620100199	32 - 34cm
2	23700620200199	35 - 37cm
3	23700620300199	38 - 41cm
4	23700620400199	42 - 45cm
5	23700620500199	46 - 49cm
6	23700620600199	50 - 53cm

Ossur Rebound® Knee Brace

- Highly breathable aerospacer material reduces heat retention and improves comfort
- Low profile hinges with extension and flexion stop kit options (ROM version) and malleable arms to provide a custom fit and knee movement control
- Removable straps allow application from right or left side and strap pull tab allow for consistent donning by patient
- Universal buttresses are included



Ossur Rebound® ROM Knee Brace

Size	Knee Circ.	Product Code Sleeve Long	Product Code Sleeve Short	Product Code Wrap Long	Product Code Wrap Short
Extra Small	29 - 35cm	708152	708052	707152	707052
Small	35 - 41cm	708153	708053	707153	707053
Medium	41 - 46cm	708155	708055	707155	707055
Large	46 - 52cm	708157	708057	707157	707057
Extra Large	52 - 57cm	708158	708058	707158	707058
XX Large	57 - 63cm	708159	708059	707159	707059
XXX Large	63 - 72cm	N/A	N/A	707160	707060

Ossur Rebound® Knee Brace

Size	Knee Circ.	Product Code Wrap Short	Product Code Sleeve Short
Extra Small	29 - 35cm	703052	704052
Small	35 - 41cm	703053	704053
Medium	41 - 46cm	703055	704055
Large	46 - 52cm	703057	704057
Extra Large	52 - 57cm	703058	704058
XX Large	57 - 63cm	703059	704059
XXX Large	63 - 72cm	707060	N/A

Circumference: 15cm above mid-patella.

Ossur Form Fit® Knee Brace

- Breathable material and easy to pull-on
- Malleable hinges, universal buttress and open poplitea
- ROM available in 30cm or 41cm length



Ossur Form Fit® Knee Brace

Size	Thigh Circumference	ROM		Non-ROM	
		Sleeve	Wrap	Sleeve	Wrap
Extra Small	33 - 39.4cm	508252	507352	504252	503252
Small	39.4 - 47cm	508253	507353	504253	503253
Medium	47 - 53.3cm	508255	507355	504255	503255
Large	53.3 - 59.7cm	508257	507357	504257	503257
Extra Large	59.7 - 67.3cm	508258	507358	504258	503258
XX Large	67.3 - 74.9cm	508259	507359	504259	503259
XXX Large	75 - 81cm	N/A	507360	N/A	503260

X = 3 (Long) or 2 (Short). Thigh Circumference: 15cm above mid-patella.

ROM Hinge Extension Stops: 10°, 20°, 30°, 40°, lockout (full extension) and Flexion Stops: 45°, 60°, 75°, 90°.

Ossur Neoprene Wrap-around Hinged Knee Support

- Dual action hinges are removable for easy cleaning
- Open popliteal area eliminates bunching and increases comfort
- Front contact closures allow for hassle-free application
- Wrap-around style accommodates all leg shape variations



Ossur Neoprene Wraparound Hinged Knee Support

Size	Product Code	Knee Circumference
Small	212003	33 - 35.5cm
Medium	212005	35.5 - 38cm
Large	212007	38 - 40.5cm
Extra Large	212008	40.5 - 43cm
XX Large	212009	43 - 45.5cm

Medi Soft OA Light

- Relief of the lateral or medial compartment using the 3-point principle
- Pain relief by reducing weight-bearing on the affected side of the joint
- Compression stabilises the joint and improves proprioception



Medi Soft OA Light

Size	Product Code - Left Varus/Right Valgus	Product Code - Right Varus/Left Valgus	Thigh Circumference
XS	915/1	914/1	31 - 37cm
S	915/2	914/2	37 - 45cm
M	915/3	914/3	45 - 51cm
L	915/4	914/4	51 - 5cm
XL	915/5	914/5	57 - 65cm
XXL	915/6	914/6	65 - 74cm

Medi Collamed® Wrap

- Physioglide hinge
- Compressive Airtex+ material with outstanding wearing comfort
- Practical, intelligent wrap fastening - easy to don and doff



Medi Collamed® Wrap

Size	Product Code	Thigh Circumference
XS	824/1	31 - 37cm
S	824/2	37 - 45cm
M	824/3	45 - 51cm
L	824/4	51 - 5cm
XL	824/5	57 - 65cm
XXL	824/6	65 - 74cm

Medi PT Control®

- Postoperative: - Reliable relief of injured or operative treated structures
- Conservative: - Correction of lateral Patella mal-tracking
- Collateral stabilisation
- Extension and flexion limitation protects against damaging joint movements and relieves injured structures
- Limitations: - Extension: 0°, 10°, 20°, 30°, 45°
- Flexion: 0°, 10°, 20°, 30°, 45°, 60°, 75°, 90°
- Immobilisation: 0°, 10°, 20°, 30°, 45°



Medi PT Control®

Size	Product Code - Left	Product Code - Right	Thigh Circumference
XS	889/1	888/1	31 - 37cm
S	889/2	888/2	37 - 45cm
M	889/3	888/3	45 - 51cm
L	889/4	888/4	51 - 5cm
XL	889/5	888/5	57 - 65cm
XXL	889/6	888/6	65 - 74cm

Medi Genumedi® Pro

- Modern easyglide hinges stabilise and support the natural roll and glide motion of the knee joint
- Circular straps at the thigh and lower leg for a secure fit and improvement of wearing comfort
- Integrated recessed grip at the upper edge of the orthosis to aid donning
- Silicone coating at the back of the thigh area helps to prevent migration

Medi Genumedi® Pro

Size	Product Code	Upper Circ.	Lower Circ.
I	617/I	37 - 40cm	25 - 28cm
II	617/II	40 - 43cm	28 - 31cm
III	617/III	43 - 46cm	31 - 34cm
IV	617/IV	46 - 49cm	34 - 37cm
V	617/V	49 - 52cm	37 - 40cm
VI	617/VI	52 - 55cm	40 - 43cm
VII	617/VII	55 - 58cm	43 - 46cm



Medi Stabimed® Wrap

- Safe collateral stabilisation by rigid frame
- Extension and flexion limitation protects against damaging joint movements and relieves injured structures
- Improvement of proprioception to increase the own guidance and stabilisation of knee joint
- Prevention of hyperextension
- Extension limitation at 0°, 10°, 20°, 30°
- Flexion limitation at: 0°, 10°, 20°, 30°, 45°, 60°, 75°, 90°

Medi Stabimed® Wrap

Size	Product Code	Thigh Circumference
XS		31 - 37cm
S	826/2	37 - 45cm
M	826/3	45 - 51cm
L	826/4	51 - 57cm
XL	826/5	57 - 65cm
XXL	826/6	65 - 74cm



Promedics Hinged Knee Sleeve

- A pull-on Neoprene sleeve, with strong metal hyperstop hinges to control medial and lateral instability
- Hook and loop straps above and below knee give improved fit

Promedics Hinged Knee Sleeve

Size	Product Code	Circumference 15cm Below Knee	Knee Circumference	Circumference 15cm Above Knee
Extra Small	HN/02	30cm	30 - 33cm	38cm
Small	HN/03	33cm	33 - 36cm	46cm
Medium	HN/05	38cm	36 - 38cm	50cm
Large	HN/07	41cm	38 - 43cm	53cm
Extra Large	HN/08	43cm	43 - 48cm	58cm
Extra Extra Large	HN/09	52cm	48 - 56cm	61cm



Breathable, comfortable and skin friendly.

Moisture-transporting material

The unique AirX™ fabric has the ability to transport moisture efficiently away from the body. The layering of fibre structures promotes a moisture wicking process, which results in a dry comfortable feeling to the surface of the skin so that body always feels fresh and dry. AirX™ gives the body optimal freedom to breathe – reduces the risk of skin maceration which results in improved patient compliance.

A pleasant surprise

It is hard not to be impressed. AirX™ is made of a soft, lightweight material that perfectly follows the contours of the body. This means that AirX™ adapts itself perfectly to the body so that it feels extremely comfortable to wear – even for long periods at a time – a feature, which is often a problem with orthopaedic and sport medical braces and supports. In this way, AirX™ is a comfortable material that helps to increased patient compliance without you even knowing!

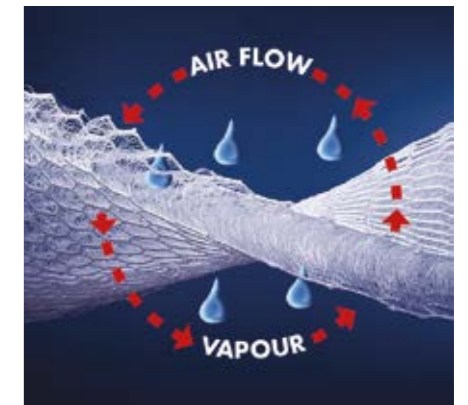

Promedics Air X SK Knee Brace

- The industry leading wrap-around knee brace for many years
- Easy to use, comfortable brace for the treatment of mediolateral instability
- Incorporates the excellent properties of AirX 3D spacer fabric
- AirX gives great compression, support, and a high degree of breathability and reduction in moisture
- Enhances comfort for extended periods of time and improves patient compliance

Air X SK Knee Brace

Size	Product Code	Knee Circumference
Extra Small	ASK/02	25 - 28cm
Small	ASK/03	28 - 34cm
Medium	ASK/05	34 - 40cm
Large	ASK/07	40 - 46cm
Extra Large	ASK/08	46 - 56cm
Extra Extra Large	ASK/09	56 - 61cm



Promedics SK Knee Brace

- Front opening design
- Easy-open tabs on hook and loop straps
- Suitable for the arthritic or elderly patient, or those with limited dexterity
- Hyperstop hinges provide medial and lateral support for the unstable knee whilst still allowing flexion



Also available in black, see page 105.

Promedics SK Knee Brace

Size	Product Code	Knee Circumference
Extra Small	SK/02	25 - 28cm
Small	SK/03	28 - 34cm
Medium	SK/05	34 - 40cm
Large	SK/07	40 - 46cm
Extra Large	SK/08	46 - 56cm
Extra Extra Large	SK/09	56 - 61cm

Promedics SK Knee Brace

- Front opening design
- Easy-open tabs on hook and loop straps
- Suitable for the arthritic or elderly patient, or those with limited dexterity
- Hyperstop hinges provide medial and lateral support for the unstable knee whilst still allowing flexion



Promedics SK Knee Brace - Black

Size	Product Code	Knee Circumference
Extra Small	SK/02/BK	25 - 28cm
Small	SK/03/BK	28 - 34cm
Medium	SK/05/BK	34 - 40cm
Large	SK/07/BK	40 - 46cm
Extra Large	SK/08/BK	46 - 56cm
Extra Extra Large	SK/09/BK	56 - 61cm

Also available in beige, see page 108.

Promedics Ventilated SK Knee Plus

- The industry leading wrap-around knee brace for many years
- Easy to use, comfortable brace for the treatment of mediolateral instability
- Features multi-perforated towel-lined latex free neoprene - reduces moisture build and improves comfort
- Provides excellent medial and lateral support
- Fully bound brace and hinge casings to enhance the overall look
- Hook and loop straps with grip-taps to assist patients with limited dexterity



Promedics Ventilated SK Knee Plus

Size	Product Code	Knee Circumference
Extra Small	VSKP/02	25 - 28cm
Small	VSKP/03	28 - 34cm
Medium	VSKP/05	34 - 40cm
Large	VSKP/07	40 - 46cm
Extra Large	VSKP/08	46 - 56cm

Promedics Sheffield VK Knee Brace

- Manufactured using ventilated neoprene for improved breathability, comfort and evaporation of moisture
- Stretch terry towel lining
- Fully bound edges improve compression, wear and durability
- Hinge casings feature fully bound edges for enhanced wear and comfort
- Refined access points for hinges offer improved aesthetics and hinge containment



Promedics Sheffield VK Knee Brace

Size	Product Code - Left	Product Code - Right	Knee Circumference
Extra Small	SVK/12	SVK/22	25 - 28cm
Small	SVK/13	SVK/23	28 - 34cm
Medium	SVK/15	SVK/25	34 - 40cm
Large	SVK/17	SVK/27	40 - 46cm
Extra Large	SVK/18	SVK/28	46 - 56cm

Promedics Sheffield SK Knee Brace

- Features polycentric hinges for improved tracking movement and medial/lateral stability
- Manufactured using ventilated neoprene for improved breathability, comfort and evaporation of moisture
- Stretch terry towel lining
- Fully bound edges improve compression, wear and durability
- Hinge casings feature fully bound edges for enhanced wear and comfort
- Refined access points for hinges offer improved aesthetics and hinge containment



Promedics Sheffield SK Knee Brace

Size	Product Code	Knee Circumference
Extra Small	SSK/02	25 - 28cm
Small	SSK/03	28 - 34cm
Medium	SSK/05	34 - 40cm
Large	SSK/07	40 - 46cm
Extra Large	SSK/08	46 - 56cm

Beagle Bea Wrap Hyperextension Straps

- Front opening
- Universal: left or right
- Contrasting proximal and distal strap to counter rotation
- Removable 10° hyperextension stop
- Posterior cross over tension straps to prevent hyperextension of the knee
- Open popliteal area for added comfort during flexion
- Easy grip tabs for patients with poor dexterity

Beagle Bea Wrap Hyperextension Straps

Size	Product Code	Knee Circumference	Price
Small	BWE/53	27 - 35.5cm	£39.16
Medium	BWE/55	33 - 40.5cm	£39.16
Large	BWE/57	38 - 45.5cm	£39.16
Extra Large	BWE/58	43 - 50cm	£39.16



Promedics VK Knee Brace

- Longer 41cm metal hyperstop hinges provide increased stability, and medial and lateral support for the unstable valgus or varus knee
- Easy-open tabs on hook and loop straps
- Suitable for the arthritic or elderly patient, or those with limited dexterity
- Sided left and right for improved fit

Promedics VK Knee Brace

Size	Product Code (Left)	Product Code (Right)	Knee Circumference
Extra Small	VK/12	VK/22	25 - 28cm
Small	VK/13	VK/23	28 - 34cm
Medium	VK/15	VK/25	34 - 40cm
Large	VK/17	VK/27	40 - 46cm
Extra Large	VK/18	VK/28	46 - 56cm
Extra Extra Large	VK/19	VK/29	56 - 61cm



Medi Genumedi®

- Massage effect silicone insert
- Improves the blood circulation and aids absorption of haematomas and oedemas
- Improves proprioception and muscular support (stabilisation of the knee)
- Easy donning
- Comfort zone in the hollow of the knee
- Lower pressure on the knee cap due to open enclosure

Medi Genumedi® - Standard

Size	Product Code	Upper Circ.	Lower Circ.
I	613/I	37 - 40cm	25 - 28cm
II	613/II	40 - 43cm	28 - 31cm
III	613/III	43 - 46cm	31 - 34cm
IV	613/IV	46 - 49cm	34 - 37cm
V	613/V	49 - 52cm	37 - 40cm
VI	613/VI	52 - 55cm	40 - 43cm
VII	613/VII	55 - 58cm	43 - 46cm

Medi Genumedi® - Extra Wide

Product Code	Upper Circ.	Lower Circ.
-	-	-
-	-	-
-	-	-
615/IV	49 - 52cm	34 - 37cm
615/V	52 - 55cm	37 - 40cm
615/VI	55 - 59cm	40 - 43cm
615/VII	58 - 61cm	43 - 46cm



Ossur Neoprene Knee Support With Stabilised Patella

- Moulded material to maintain a low profile
- Accordion moulding in the popliteal area eliminates bunching

Ossur Neoprene Knee Support With Stabilised Patella

Size	Product Code	Knee Circumference
Small	302563BLK	29 - 33cm
Medium	302565BLK	33 - 37cm
Large	302567BLK	37 - 41cm
Extra Large	302568BLK	41 - 44cm
XX Large	302569BLK	44 - 48cm



Promedics Buttress Knee Sleeve

- A standard Neoprene knee sleeve with open patella, incorporating a buttress pad
- Can be selected with a buttress pad to oppose medial/lateral patella migration
- Buttress pad positions defined as viewed by the patient, e.g. left buttress pad gives lateral support to the left leg and medial support to the right leg
- Full buttress also available

Promedics Buttress Knee Sleeve

Size	Product Code (Left)	Product Code (Right)	Circumference 15cm Below Knee	Knee Circumference	Circumference 15cm Above Knee
Extra Small	BN/12	BN/22	30cm	30 - 33cm	38cm
Small	BN/13	BN/23	33cm	33 - 36cm	46cm
Medium	BN/15	BN/25	38cm	36 - 38cm	50cm
Large	BN/17	BN/27	41cm	38 - 43cm	53cm
Extra Large	BN/18	BN/28	43cm	43 - 48cm	58cm
Extra Extra Large	BN/19	BN/29	52cm	48 - 56cm	61cm



Promedics Stabilised Knee Sleeve

- A pull-on Neoprene sleeve incorporating a buttress pad, spiral stays for medial and lateral support, and hook and loop straps above and below the knee for improved fit
- Can be selected with a buttress pad to oppose medial/lateral patella migration
- Buttress pad positions defined as viewed by the patient, e.g. left buttress pad gives lateral support to the left leg and medial support to the right leg
- Full buttress also available

Promedics Stabilised Knee Sleeve

Size	Product Code (Left)	Product Code (Right)	Circumference 15cm Below Knee	Knee Circumference	Circumference 15cm Above Knee
Extra Small	ST/12	ST/22	30cm	30 - 33cm	38cm
Small	ST/13	ST/23	33cm	33 - 36cm	46cm
Medium	ST/15	ST/25	38cm	36 - 38cm	50cm
Large	ST/17	ST/27	41cm	38 - 43cm	53cm
Extra Large	ST/18	ST/28	43cm	43 - 48cm	58cm
Extra Extra Large	ST/19	ST/29	52cm	48 - 56cm	61cm



Ossur Neoprene Knee Sleeve

- A neoprene sleeve-design knee support providing compression and warmth
- Unique accordion design enhances comfort by eliminating bunching in the popliteal area
- Open or closed patella

Ossur Neoprene Knee Sleeve

Size	Knee Circumference	Product Code - 0.3cm Neoprene Open Patella	Product Code - 0.6cm Neoprene Open Patella
Small	29 - 33cm	402013BLK	302013BLK
Medium	33 - 37cm	402015BLK	302015BLK
Large	37 - 41cm	402017BLK	302017BLK
Extra Large	41 - 44cm	402018BLK	302018BLK
XX Large	44 - 48cm	402019BLK	302019BLK



Promedics Economy Knee Sleeve

- Neoprene sleeve with open patella
- Provides warmth and light compressional support



Promedics Economy Knee Sleeve

Size	Product Code	Circumference 15cm Below Knee	Knee Circumference	Circumference 15cm Above Knee
Extra Small	EN/02	30cm	30 - 33cm	38cm
Small	EN/03	33cm	33 - 36cm	46cm
Medium	EN/05	38cm	36 - 38cm	50cm
Large	EN/07	41cm	38 - 43cm	53cm
Extra Large	EN/08	43cm	43 - 48cm	58cm
Extra Extra Large	EN/09	52cm	48 - 56cm	61cm

Promedics Lycrafleece Patella Lux

- Provides medial or lateral stabilisation of the knee
- Crescent shaped buttress pad can be placed on the medial or lateral side of the patella
- Non-slip rubber lining ensures the support does not move after fitting
- Ideal for lateral or medial subluxation of the patella
- Universal design fits left and right



Promedics Lycrafleece Patella Lux

Size	Product Code	Knee Circumference
Extra Small	BLPL/02	25 - 28cm
Small	BLPL/03	28 - 36cm
Medium	BLPL/05	33 - 41cm
Large	BLPL/07	38 - 46cm
Extra Large	BLPL/08	45 - 55cm

Thuasne Patellar Bandage

- Applies local pressure over the patellar tendon and supports the kneecap due to its anatomical shape



Thuasne Patellar Bandage

Product Code	Size
23040129900399	Universal

Promedics Jura Three Panel Immobiliser

- Universal three panel knee immobiliser
- Return hook/loop fastenings
- Removable aluminium stays
- Bound edge



Promedics Jura Three Panel Immobiliser

Product Code	Splint Length
JTI/12	30cm
JTI/14	36cm
JTI/16	41cm
JTI/18	46cm
JTI/20	51cm
JTI/22	56cm
JTI/24	61cm
JTI/26	66cm
JTI/28	71cm

Promedics Post-Op Knee Splint

- A three panel splint made in foam laminate
- Two detachable side panels can be positioned to fit most leg circumferences
- The four steels are removable for the patient to launder the splint
- Splint length is 51cm



Promedics Post-Op Knee Splint

Product Code	Size
PKS/20	Universal



Hip

Brace Orthopaedic DynaCox Evolution™ Hip Brace

- A functional combination of orthosis and bandage, this close fitting orthosis offers a controlled range of movement
- Helps maintain containment of the hip by use of counter-forces, generated by pre tensioned design. Lateral side bar constructed at an abduction angle of 20°, so when the patient works against this force by adducting and flexing, the brace responds with a counter force through the femoral pad to give the containment required
- Bandage provides compression and helps reduce excessive flexion of the hip
- Significantly reduces the risk of dislocation, whilst allowing normal muscle action



DynaCox Evolution™ Hip Brace

Size	Hip Circumference	Product Code (Left)	Product Code (Right)
Small	70 - 85cm	23.600.101.01 DYNACOX EVOLUTION Lt S ROM	23.600.201.01 DYNACOX EVOLUTION Rt S ROM
Medium	85 - 100cm	23.600.102.01 DYNACOX EVOLUTION Lt M ROM	23.600.202.01 DYNACOX EVOLUTION Rt M ROM
Large	100 - 120cm	23.600.103.01 DYNACOX EVOLUTION Lt L ROM	23.600.203.01 DYNACOX EVOLUTION Rt L ROM
Extra Large	115 - 135cm	23.600.104.01 DYNACOX EVOLUTION Lt XI ROM	23.600.204.01 DYNACOX EVOLUTION Rt XI ROM
Extra Extra Large	135 - 150cm	23.600.105.01 DYNACOX EVOLUTION Lt Xxl ROM	23.600.205.01 DYNACOX EVOLUTION Rt Xxl ROM

Restorative Medical RestAir Hip

- Comfortably and safely treats hip adduction and scissoring
- RestAir technology uses 4 air bladders (2 on each side) to redistribute skin pressure and gradually increase the hip's range of motion
- Wide cuff straps provide comfort, increasing likelihood of patient compliance
- Spreader Bar Assembly with 3 choices of abductor-bar length provides greater hip abduction when needed
- Flex Technology orthosis moves with the patient's abnormal muscle tone and spasticity for comfort and helps to relax the tone
- Hand-bulb air pump included



Restorative Medical RestAir Hip

Size	Product Code	Hip Circumference
Extra Small	RM0284	15 - 30cm
Small	RM0285	28 - 43cm
Large	RM0286	40 - 56cm
Extra Large	RM0287	53 - 66cm

Medi Orthocox

- Simple, time-saving application
- Very comfortable to wear due to highly permeable fabric and skin-friendly material
- Label fixed to the outside of the product so it does not irritate the operation scar

Medi Orthocox

Size	Product Code - Left	Product Code - Right	Hip Circ. (A)	Thigh Circ. (B)
Small	873/2	872/2	70 - 90cm	50 - 60cm
Medium	873/3	872/3	85 - 105cm	55 - 70cm
Large	873/4	872/4	100 - 120cm	65 - 80cm
Extra Large	873/5	872/5	115 - 140cm	75 - 90cm
Extra Extra Large	873/6	872/6	130 - 160cm	75 - 90cm

Measures: (A) Circumference of hip
(B) Circumference of thigh measured 5cm below the crotch





Wrist, Elbow and Shoulder

Promedics Plastic Mallet Finger Splint

- Supports the DIP joint in neutral, to help correct mallet deformity, while protecting the distal phalanx and extending the PIP joint
- Perforated design prevents skin maceration



Promedics Plastic Mallet Finger Splint

Size	Product Code	Circ at PIP Joint
S	MFS/1	4.5 - 5cm
S-M	MFS/2	5 - 5.5cm
M	MFS/3	6 - 6.5cm
M-L	MFS/4	6.5 - 7cm
L	MFS/5	7 - 7.5cm
L-XL	MFS/5.5	7.5 - 8cm
XL	MFS/6	8 - 8.5cm

Promedics Oval-8 Finger Splint

- Made of 1.6mm high-temperature polypropylene
- Can be adjusted with a heat gun for a small angle alteration
- Can be used to correct Swan Neck, Boutonniere and Mallet deformities,
- Available in 13 sizes, corresponding to jeweller's ring sizes - each splint fits both a full and half ring size
- Sizing Set includes one each of splint size 3-14 and the ring gauge



Promedics Plastic Mallet Finger Splint - Pack of 5

Size	Product Code	Size	Product Code	Size	Product Code
2	P1008-2-5	7	P1008-7-5	12	P1008-12-5
3	P1008-3-5	8	P1008-8-5	13	P1008-13-5
4	P1008-4-5	9	P1008-9-5	14	P1008-14-5
5	P1008-5-5	10	P1008-10-5	15	P1008-15-5
6	P1008-6-5	11	P1008-11-5		

Promedics Plastic Mallet Finger Splint - Sizing Set

P1008-S

Inflatable Carrot for KSA

- Positions fingers away from palm to protect skin from excessive moisture, pressure, and risk of nail puncture injuries
- Velvety, bacteriostatic cloth cover
- Deflated Carrot is gently pulled into place using wand provided then gradually inflated
- 7-1/4"L, 5-3/4" maximum circumference (fully inflated)
- Kit contains: 1 Inflatable Carrot, 2 cloth covers, 1 inflator bulb, 2 Magic Wands (one required per Carrot)
- Replacement Accessories available (sold separately)



Inflatable Carrot for KSA

Product Code Description

51595	Accessory Kit
51598	Inflatable Carrot & Accessory Kit
51594	Inflatable Carrot Finger Orthosis (Carrot Only)

Promedics Standard Wrist Brace

- 18 cm wrist brace made of quality woven elastic for comfort and durability
- Enclosing an aluminium palmar bar which can be easily shaped to fit the wrist
- Unique overlapped edges offer excellent comfort especially to minimise chafing at the thumb web and palmar crease



Standard Wrist Brace

Size	Left	Right	Wrist Circumference
Extra Small	SWB/12	SWB/22	11.5 - 13cm
Small	SWB/13	SWB/23	14 - 15cm
Medium	SWB/15	SWB/25	16.5 - 18cm
Large	SWB/17	SWB/27	20 - 21.5cm
Extra Large	SWB/18	SWB/28	23 - 24cm

Promedics Beta Wrist Brace

- 18cm wrist brace made of a dual compression elastic
- Vinyl pocket encloses an aluminium palmar bar, which can be shaped to the wrist
- Lycra binding finishes the edges for comfort and prevents chafing at the thumb web
- Also available in beige



Beta Wrist Brace

Size	Left (Beige)	Right (Beige)	Left (Black)	Right (Black)	Wrist Circumference
Extra Small	BWB/12	BWB/22	BWB/12/BK	BWB/22/BK	11.5 - 13cm
Small	BWB/13	BWB/23	BWB/13/BK	BWB/23/BK	14 - 15cm
Medium	BWB/15	BWB/25	BWB/15/BK	BWB/25/BK	16.5 - 18cm
Large	BWB/17	BWB/27	BWB/17/BK	BWB/27/BK	20 - 21.5cm
Extra Large	BWB/18	BWB/28	BWB/18/BK	BWB/28/BK	23 - 24cm

Promedics Nuform Wrist Brace

- 18cm wrist brace, made of a ventilated elastic for cool comfort
- Vinyl pocket encloses an aluminium palmar bar, which can be shaped to the wrist
- Lycra binding finishes the splint edges for a comfortable fit and prevents chafing at the thumb web
- Also available in black



Nuform Wrist Brace

Size	Left	Right	Wrist Circumference
Extra Small	NUF/12	NUF/22	11.5 - 13cm
Small	NUF/13	NUF/23	14 - 15cm
Medium	NUF/15	NUF/25	16.5 - 18cm
Large	NUF/17	NUF/27	20 - 21.5cm
Extra Large	NUF/18	NUF/28	23 - 24cm

Promedics Neobrace Wrist Brace

- Made in Neoprene which retains heat to soothe painful joints
- Conforms well and can be cut to fit swollen, arthritic joints without fraying
- Available in Standard 18cm length and Long 23cm length



Neobrace Wrist Brace - Standard

Size	Left	Right	Wrist Circumference
Extra Small	SNB/12	SNB/22	11.5 - 13cm
Small	SNB/13	SNB/23	14 - 15cm
Medium	SNB/15	SNB/25	16.5 - 18cm
Large	SNB/17	SNB/27	20 - 21.5cm
Extra Large	SNB/18	SNB/28	23 - 24cm

Neobrace Wrist Brace - Long

Size	Left	Right	Wrist Circumference
Extra Small	LNB/12	LNB/22	11.5 - 13cm
Small	LNB/13	LNB/23	14 - 15cm
Medium	LNB/15	LNB/25	16.5 - 18cm
Large	LNB/17	LNB/27	20 - 21.5cm
Extra Large	LNB/18	LNB/28	23 - 24cm

Promedics Deltaform Wrist Brace

- 18cm woven elastic/cotton support
- Aluminium stay inside a vinyl pocket and longitudinal seam for excellent conformity to the wrist and forearm
- Also available in beige
- **Contains latex**



Deltaform Wrist Brace

Size	Left (Beige)	Right (Beige)	Left (Black)	Right (Black)	Wrist Circumference
Extra Small	DFS/12	DFS/22	DFS/12/BK	DFS/22/BK	11.5 - 13cm
Small	DFS/13	DFS/23	DFS/13/BK	DFS/23/BK	14 - 15cm
Medium	DFS/15	DFS/25	DFS/15/BK	DFS/25/BK	16.5 - 18cm
Large	DFS/17	DFS/27	DFS/17/BK	DFS/27/BK	20 - 21.5cm
Extra Large	DFS/18	DFS/28	DFS/18/BK	DFS/28/BK	23 - 24cm

Promedics Lacer Wrist

- A premium orthosis for support and stabilisation of the wrist
- Conformable stay and wrist strap to aid stabilisation
- Lacing closure allows for easy one-handed application
- Palmar pad provides additional comfort and support



Promedics Lacer Wrist Short

Size	Left	Right
Extra Extra Small	LCRS/11	LCRS/21
Extra Small	LCRS/12	LCRS/22
Small	LCRS/13	LCRS/23
Medium	LCRS/15	LCRS/25
Large	LCRS/17	LCRS/27
Extra Large	LCRS/18	LCRS/28

Promedics Lacer Wrist Long

Size	Left	Right
Extra Small	LCRL/12	LCRL/22
Small	LCRL/13	LCRL/23
Medium	LCRL/15	LCRL/25
Large	LCRL/17	LCRL/27
Extra Large	LCRL/18	LCRL/28



Promedics Delta Wrist Plus Wrist Brace

- Longer, 23cm woven elastic/cotton support
- Aluminium stay inside a vinyl pocket and longitudinal seam for excellent conformity to the wrist and forearm
- Extends to 2/3 of the forearm for radial/ulnar stability
- Also available in black



Delta Wrist Plus Wrist Brace

Size	Left (Beige)	Right (Beige)	Left (Black)	Right (Black)	Wrist Circumference
Extra Small	DFP/12	DFP/22	DFP/12/BK	DFP/22/BK	11.5 - 13cm
Small	DFP/13	DFP/23	DFP/13/BK	DFP/23/BK	14 - 15cm
Medium	DFP/15	DFP/25	DFP/15/BK	DFP/25/BK	16.5 - 18cm
Large	DFP/17	DFP/27	DFP/17/BK	DFP/27/BK	20 - 21.5cm
Extra Large	DFP/18	DFP/28	DFP/18/BK	DFP/28/BK	23 - 24cm

Promedics Poroflex Pull

- Simple 'slip-on' design with two strap D ring closures
- Ideal for patients with limited dexterity
- Adjustable aluminium palmar bar with flexible dorsal stays
- Excellent wrist compression and stability



Poroflex Lace

Size	Left	Right	Wrist Circumference
Extra Small	PFWB/12	PFWB/22	11.5 - 13cm
Small	PFWB/13	PFWB/23	14 - 15cm
Medium	PFWB/15	PFWB/25	16.5 - 18cm
Large	PFWB/17	PFWB/27	20 - 21.5cm
Extra Large	PFWB/18	PFWB/28	23 - 24cm

Thuasne Ligaflex® Classic Wrist Brace

- Firm wrist support with conformable palm reinforcement
- Anti-bacterial 3D knit, which makes the brace lightweight and breathable for effective moisture-wicking
- Suitable for long term wear, with 2 in 1 straps for an even support



Thuasne Ligaflex® Classic Wrist Brace

Size	Product Code - Left	Product Code - Right	Wrist Circumference
1	24350220100302	24350220100301	13 - 15cm
2	24350220200302	24350220200301	15.5 - 17.5cm
3	24350220300302	24350220300301	18 - 20cm
4	24350220400302	24350220400301	20.5 - 23cm

Thuasne Ligaflex® Pro

- Rigid, anatomical, and conformable palmar stay restricts joint movement
- Aerated lining for comfortable wear
- Ease of application due to patented Quick Lacing System*, which provides quick and even tightening
- Bilateral model



Thuasne Ligaflex® Pro

Size	Product Code	Wrist Circumference
1	24330220100199	13 - 15cm
2	24330220200199	15.5 - 17.5cm

Promedics Intrinsic Wrist Brace

- Padded elastic wrist brace
- Full-length adjustable aluminium resting splint
- Wide enough to contain all four fingers and can be easily adjusted to hold the wrist and fingers in the desired position
- Features a wide, padded adjustable dorsal closure strap that can be used to hold the fingers in position



Intrinsic Wrist Brace

Size	Left	Right	Wrist Circumference
Extra Small	IWB/12	IWB/22	11.5 - 13cm
Small	IWB/13	IWB/23	14 - 15cm
Medium	IWB/15	IWB/25	16.5 - 18cm
Large	IWB/17	IWB/27	20 - 21.5cm
Extra Large	IWB/18	IWB/28	23 - 24cm

Turtlebrace Wrist

- 'Apply and forget' type brace made of a stratification of multi-perforated low-temperature thermoplastic and microfibre fabric
- Flexibility of components stabilises joint more easily and precisely than a traditional brace or cast
- Can be reshaped multiple times, without losing its qualities - allows adjustment due to swelling or morphological changes



Turtlebrace Wrist

Size	Product Code - Hook and Loop	Product Code - Zipper	Wrist Circumference
Adult - Small	TBPAV-01	TBPAZ-01	15.2cm - 24.3cm
Adult - Medium	TBPAV-02	TBPAZ-02	17.6cm - 28.2cm
Adult - Large	TBPAV-03	TBPAZ-03	20cm - 32cm



Turtlebrace Finger Add-ons

- Auto-fusing finger extension that can be applied on the popular Turtlebrace wrist or the Harebrace wrist
- Unique design facilitates immobilisation where required
- Flexibility of components stabilises fingers more easily and precisely than a traditional brace or cast
- Can be cut to fit
- Can be reshaped multiple times, without losing its qualities - allows adjustment due to morphological changes or specific protocols
- Universal size
- Universal Finger Splint can be used to splint fractured fingers when a wrist brace is not required



Turtlebrace Finger Add-ons

Size	Product Code - Fingers	Product Code - Thumb
Universal	EDUA	EPUA



Turtlebrace Finger Splint

Size	Product Code
Universal	DUA

Promedics Wrightington Neobrace

- 18cm wrist brace with easy-open overstitched hook and loop tabs
- Ideal for the patient with limited dexterity.
- Made in Neoprene which retains heat to soothe painful joints
- Conforms well and can be cut to fit swollen arthritic joints without fraying



Wrightington Neobrace

Size	Left	Right	Wrist Circumference
Extra Small	WNB/12	WNB/22	11.5 - 13cm
Small	WNB/13	WNB/23	14 - 15cm
Medium	WNB/15	WNB/25	16.5 - 18cm
Large	WNB/17	WNB/27	20 - 21.5cm
Extra Large	WNB/18	WNB/28	23 - 24cm

Promedics Wrist/Ulnar Deviation Support

- Unique functional splint to correct early MCP Ulnar Deviation (U.D.) deformity and provide wrist support for patients with Rheumatoid arthritis
- Made in ventilated Neoprene with a towelling to reduce heat build up and reduce perspiration
- Incorporates a malleable aluminium palmar bar, which can be shaped to fit the wrist

Wrist/Ulnar Deviation Support

Size	Left	Right	Wrist Circumference
Extra Small	UDSA/12	UDSA/22	11.5 - 13cm
Small	UDSA/13	UDSA/23	14 - 15cm
Medium	UDSA/15	UDSA/25	16.5 - 18cm
Large	UDSA/17	UDSA/27	20 - 21.5cm
Extra Large	UDSA/18	UDSA/28	23 - 24cm



Promedics Procool D-ring Wrist Splint

- Low profile support with circumferential slip-on design and D-Ring fastening to allow easier one handed application
- Aluminium palmar bar can be removed for further adjustment
- Dorsal stockinette lining facilitates application and cushions strap closures
- Standard and Firm braces allow full finger and thumb function whilst limiting wrist flexion
- Firm splint has the addition of adjustable dorsal stays to reduce unwanted flexion and extension and improve overall immobilisation of acute soft tissue injuries
- Can be trimmed if required

Procool D-ring Wrist Splint

Size	Left (Standard)	Right (Standard)	Left (Firm)	Right (Firm)	Wrist Circumference
Extra Small	PDR/12	PDR/22	PDRF/12	PDRF/22	> 15cm
Small	PDR/13	PDR/23	PDRF/13	PDRF/23	15 - 17cm
Medium	PDR/15	PDR/25	PDRF/15	PDRF/25	17 - 19cm
Large	PDR/17	PDR/27	PDRF/17	PDRF/27	19 - 22cm
Extra Large	PDR/18	PDR/28	PDRF/18	PDRF/28	22cm +

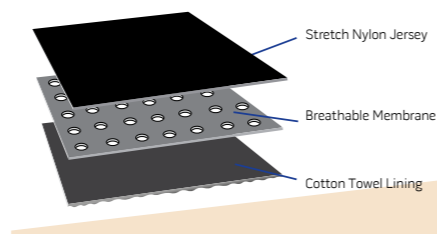

Procool Procool is a range of lightweight and breathable splints producing excellent compression and support for a wide range of conditions and injuries. Made with tiny perforations in the Neoprene for comfortable wear and a terry cloth lining that feels good against the skin. Procool offers you just the fit you want - excellent stability without excessive bulk.

Promedics Black Wrist Brace

- Immobilises and protects the wrist following tendonitis and other soft tissue injuries such as sprains/strains, and post-trauma healing
- Lightweight, breathable and contoured for a comfortable fit
- Slide-on design with D-ring closures allow easy application

Black Wrist Brace

Size	Left	Right	Wrist Circumference
Extra Small	JRWB/12	JRWB/22	> 15 cm
Small	JRWB/13	JRWB/23	15 - 17cm
Medium	JRWB/15	JRWB/25	17 - 19cm
Large	JRWB/17	JRWB/27	19 - 22cm
Extra Large	JRWB/18	JRWB/28	23 - 25cm

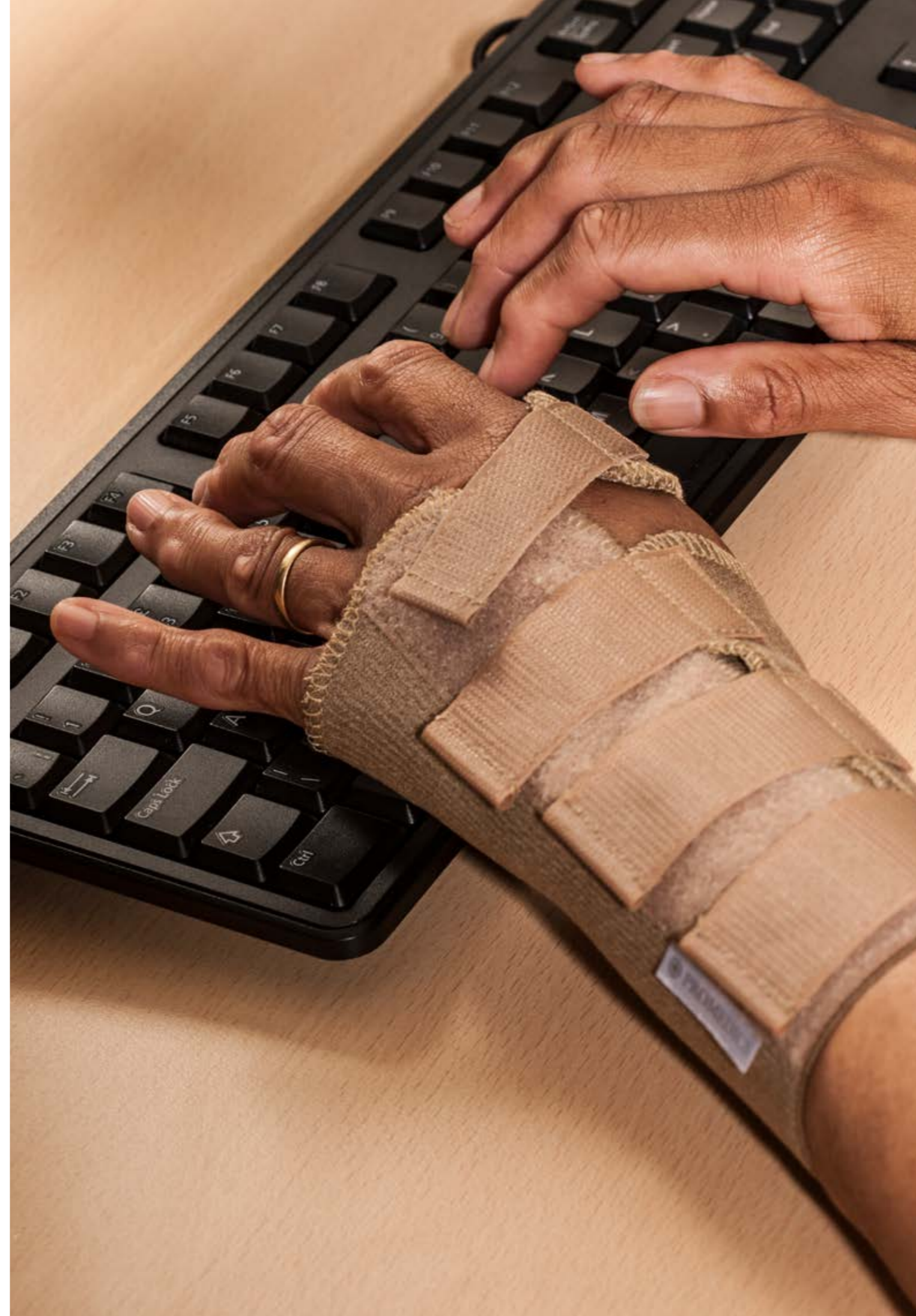

Promedics Poroflex Pull & Thumb

- Simple 'slip-on' design with two strap D ring closures
- Ideal for patients with limited dexterity
- Thumb extension for MCP and CMC control
- Adjustable aluminium thumb stay
- Adjustable aluminium palmar bar with flexible dorsal stays
- Excellent wrist compression and stability



Poroflex Pull & Thumb

Size	Left	Right	Wrist Circumference
Extra Small	PFTB/12	PFTB/22	11.5 - 13cm
Small	PFTB/13	PFTB/23	14 - 15cm
Medium	PFTB/15	PFTB/25	16.5 - 18cm
Large	PFTB/17	PFTB/27	20 - 21.5cm
Extra Large	PFTB/18	PFTB/28	23 - 24cm

Thuasne Ligaflex® Pro+

- Rigid, anatomical, and conformable palmar and thumb stays restrict wrist and thumb joints movements
- Aerated lining for comfortable wear
- Ease of application due to patented Quick Lacing System*, which provides quick and even tightening
- Available in right or left model



Thuasne Ligaflex® Pro+

Size	Product Code - Left	Product Code - Right	Wrist Circumference
1	24340220100102	24340220100101	13 - 15cm
2	24340220200102	24340220200101	15.5 - 17.5cm
3	24340220300102	24340220300101	18cm - 20cm
4	24340220400102	24340220400101	20.5cm - 23cm

Promedics Black Wrist/Thumb Brace

- Immobilises and protects the wrist and thumb following tendonitis and other soft tissue injuries such as sprains/strains, and post-trauma healing
- Lightweight, breathable and contoured for a comfortable fit
- Slide-on design with D-ring closures allow easy application



Black Wrist/Thumb Brace

Size	Left	Right	Wrist Circumference
Extra Small	JRWTB/12	JRWTB/22	> 15cm
Small	JRWTB/13	JRWTB/23	15 - 17cm
Medium	JRWTB/15	JRWTB/25	17 - 19cm
Large	JRWTB/17	JRWTB/27	19 - 22cm
Extra Large	JRWTB/18	JRWTB/28	23 - 25cm

Thuasne Ligaflex® Rhizo Thumb Splint

- The Ligaflex Rhizo is a thumb spica that immobilises the thumb in a painless position by a patented wire frame in the thumb web space. An opening in the thumb column prevents any pressure on the painful zone. Particularly suitable for basal thumb arthritis. The anti-bacterial 3D knit is lightweight and breathable for effective moisture wicking. The Ligaflex Classic Open is ambidextrous.



LIGHT TO MODERATE SPRAIN

Thuasne Ligaflex® Rhizo Thumb Splint

Size	Product Code - Left	Product Code - Right	Wrist Circumference
1	70900220101402	70900220101401	13 - 17cm
2	70900220201402	70900220201401	17 - 23cm

Promedics Thumbs Up

- Lightweight structure and comfortable fitting thumb spica
- Innovative design with breathable holes
- Protection glove and contact closure make this thumb spica an easy to use, well fitting solution for thumb care
- Anatomically shaped, provides the right immobilisation to relieve pain during everyday activities



Thumbs Up

Size	Left	Right	Wrist Circumference
Small	TUJ/13	TUJ/23	13 - 17cm
Medium	TUJ/15	TUJ/25	17 - 19cm
Large	TUJ/17	TUJ/27	19 - 23cm
Extra Large	TUJ/18	TUJ/28	23 - 28cm

Promedics CMC Thumb Splint

- Ergonomic frame provides superior support and excellent comfort of CMC joint
- Inner mouldable aluminium stay offers extra support and stability of thumb
- Easy to apply and adjust with simple straps



Jura CMC Thumb Splint

Size	Left	Right	Circumference of Hand Below the Fingers
Small	JURACMC/13	JURACMC/23	16 - 19cm
Medium	JURACMC/15	JURACMC/25	19 - 23cm
Large	JURACMC/17	JURACMC/27	23 - 26cm

Promedics Abducted Thumb Wrap

- Neoprene wrist/thumb wrap with a hook and loop closure
- Incorporates a flexible stay to hold the thumb firmly in abduction



Abducted Thumb Wrap

Size	Left	Right	Wrist Circumference
Extra Large	ATW/12	ATW/22	11.5 - 13cm
Small	ATW/13	ATW/23	14 - 15cm
Medium	ATW/15	ATW/25	16.5 - 18cm
Large	ATW/17	ATW/27	20 - 22cm

Promedics Wrist Thumb Wrap

- Holds the thumb lightly in abduction and stabilises the wrist with a double wrist wrap in Neoprene
- Universal design fits left and right



Wrist Thumb Wrap

Size	Product Code	Wrist Circumference
Small	WTW/03	14 - 15cm
Medium	WTW/05	16.5 - 18cm
Large	WTW/07	20 - 22cm
Extra Large	WTW/08	22 - 24cm

Promedics Wrist Thumb Wrap

- Latex free neoprene with terry plush lining makes this a very comfortable support
- Full finger flexion whilst giving good circumferential compression and support to the wrist and thumb
- Easily fastened using hook and loop closures
- Fits either left or right hand and can be trimmed in areas for a custom fit



Wrist Thumb Wrap

Size	Product Code	Wrist Circumference
Small	JTWWS/03/BEI	Up to 17cm
Medium	JTWWS/05/BEI	17 - 19cm
Large	JTWWS/07/BEI	19cm +

Promedics Neoprene Wrist Thumb Brace

- A malleable aluminium thumb stay holds the thumb firmly in abduction, supporting the thumb MP joint and restricting movement at the CMC joint



Neoprene Wrist Thumb Brace

Size	Left	Right	Wrist Circumference
Extra Small	WTO/12	WTO/22	11.5 - 13cm
Small	WTO/13	WTO/23	14 - 15cm
Medium	WTO/15	WTO/25	16.5 - 18cm
Large	WTO/17	WTO/27	20 - 21.5cm
Extra Large	WTO/18	WTO/28	23 - 24cm

Promedics Pollo Form Spica - Standard

- Unique two-way stretch material gives the Pollo Form excellent properties for supporting the wrist and thumb
- Outer material is durable and supports an inner pocket with a pre-cut low temperature thermoplastic insert
 - The insert is activated by pouring warm water into the pocket
 - After removing the water the brace is then fitted to the patient whilst forming the insert to hold the thumb in the required position
 - The insert can be reactivated to allow serial adjustments or removed later in the treatment programme
- The Long version gives greater control around the wrist



Pollo Form Spica - Standard

Size	Left	Right	Wrist Circumference
Extra Small	SPF/12	SPF/22	Up to 14cm
Small	SPF/13	SPF/23	14 - 16cm
Medium	SPF/15	SPF/25	16 - 19cm
Large	SPF/17	SPF/27	19 - 21cm
Extra Large	SPF/18	SPF/28	21 - 24cm

Promedics Pollo Form Spica - Long

Pollo Form Spica - Long

Size	Left	Right	Wrist Circumference
Extra Small	LPF/12	LPF/22	Up to 14cm
Small	LPF/13	LPF/23	14 - 16cm
Medium	LPF/15	LPF/25	16 - 19cm
Large	LPF/17	LPF/27	19 - 21cm
Extra Large	LPF/18	LPF/28	21 - 24cm



Promedics Procool Thumb Restriction Splint

- Providing full finger function, this very low profile wrap around support provides adjustable support for the thumb CMC joint in the treatment of osteoarthritis and medial subluxation
- Shaped strap wraps around the thumb CMC joint and the first metacarpal for targeted CMC joint support.
- Extensive size range covers paediatric to adult sizes
- Plus (+) sizes are a full size bigger in thumb circumference to fit oedematous thumb conditions
- Function and fit without bulk
- Can be trimmed if required
- Available in black and beige



Procool Thumb Restriction Splint

Size	Left (Beige)	Right (Beige)	Left (Black)	Right (Black)	Wrist Circumference
Infant	N/A	N/A	PTRS/11	PTRS/21	11 - 14cm
Child	N/A	N/A	PTRS/12	PTRS/22	14 - 17cm
Small	PTRSB/13	PTRSB/23	PTRS/13	PTRS/23	15 - 18cm
Small+	PTRSB/13+	PTRSB/23+	PTRS/13+	PTRS/23+	17 - 18cm
Medium	PTRSB/15	PTRSB/25	PTRS/15	PTRS/25	18 - 20cm
Medium+	PTRSB/15+	PTRSB/25+	PTRS/15+	PTRS/25+	20 - 21cm
Large	PTRSB/17	PTRSB/27	PTRS/17	PTRS/27	20 - 23cm
Large+	PTRSB/17+	PTRSB/27+	PTRS/17+	PTRS/27+	21 - 24cm
Extra Large	PTRSB/18	PTRSB/28	PTRS/18	PTRS/28	23 - 25cm

*Procool

Procool is a range of lightweight and breathable splints producing excellent compression and support for a wide range of conditions and injuries. Made with tiny perforations in the Neoprene for comfortable wear and a terry cloth lining that feels good against the skin. Procool offers you just the fit you want - excellent stability without excessive bulk.

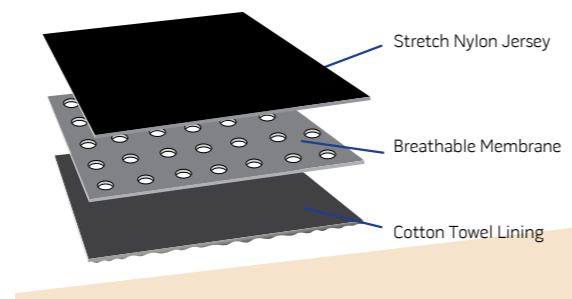

Breathable, comfortable and skin friendly.

Moisture-transporting material

The unique AirX™ fabric has the ability to transport moisture efficiently away from the body. The layering of fibre structures promotes a moisture wicking process, which results in a dry comfortable feeling to the surface of the skin so that body always feels fresh and dry. AirX™ gives the body optimal freedom to breathe – reduces the risk of skin maceration which results in improved patient compliance.

A pleasant surprise

It is hard not to be impressed. AirX™ is made of a soft, lightweight material that perfectly follows the contours of the body. This means that AirX™ adapts itself perfectly to the body so that it feels extremely comfortable to wear – even for long periods at a time – a feature, which is often a problem with orthopaedic and sport medical braces and supports. In this way, AirX™ is a comfortable material that helps to to increased patient compliance without you even knowing!

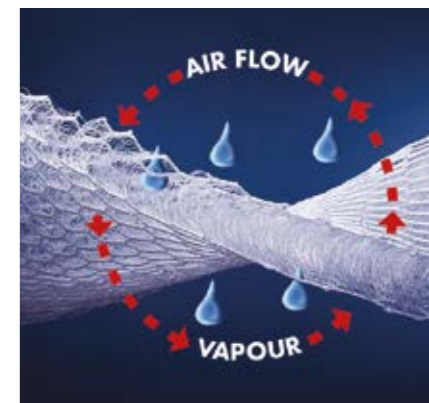

Promedics Air X Thumb Spica

- Adjustable thumb Spica offering support around the wrist, MCP and CMC joints
- AirX offers improved properties
- Breathable
- Vapour transfer for reduced moisture
- Skin friendly
- Comfort, compression and conforms



Air X Thumb Spica

Size	Left	Right	Wrist Circumference
Small	ATS/13	ATS/23	14 - 15cm
Medium	ATS/15	ATS/25	15 - 16.5cm
Large	ATS/17	ATS/27	16.5 - 18cm
Extra Large	ATS/18	ATS/28	18 - 19cm

Promedics Palm Protector Available direct from Sheffield stock

- Fleece lined lightweight palm cover
- Designed to allow full finger movement whilst reducing finger contractures and skin damage breakdown in the palmar region
- Easily laundered and is easily applied using hook and loop fastening
- One size fits all



Palm Protector	
Left	Right
JPC/L	JPC/R

Brace Orthopaedic Artisan Palmar Forearm Splint

- Immobilisation of the wrist, thumb and fingers, pre-operatively, post-operatively, or for the management of fractures, including replacement of previously fitted plaster cast



Artisan Palmar Forearm Splint

Size	Measurement	Product Code	Left/Right
Small/Medium	Tip of middle finger to wrist 16 - 19cm	55011	Universal
Large	Tip of middle finger to wrist > 19cm	55012	Universal

Ossur SoftPro® Grip Available direct from Sheffield stock

- Color coded straps
- Palmar bar comfortably fits into the palm of a fist
- Two incrementally larger palmar rolls included to gradually increase extension of the MCP and PIP joints



SoftPro® Grip

Size	Left	Right	Width of MP Joint	Length
Small	SP31FG-S-L	SP31FG-S-R	6.5 - 7.5cm	23cm
Medium	SP31FG-M-L	SP31FG-M-R	7.5 - 9cm	25cm
Large	SP31FG-L-L	SP31FG-L-R	9 - 10cm	28cm

Allard S.O.T. Resting Splint

- Smooth and lightweight with an aluminium core allowing adjustment to the desired position
- The aluminium core is embedded into polyethylene foam and covered with fabric
- Accessories available: - Additional cover - Extra wrist strap - Finger divider - MCP wedges in three sizes



S.O.T. Resting Splint

Size	Product Code Left	Product Code Right	MCP Width	Wrist to Finger Tip
Extra Extra Extra Small	287101008	287102008	5.5cm	≤ 12cm
Extra Extra Small	287101009	287102009	≤ 6.5cm	≤ 14cm
Extra Small	287101010	287102010	≤ 7.5cm	≤ 16cm
Small	287101011	287102011	≤ 7.5cm	≤ 18.5cm
Medium	287101012	287102012	≤ 8.5cm	≤ 20cm
Large	287101013	287102013	≤ 9cm	≤ 21cm



Additional Cover

Size	Product Code Left	Product Code Right
Extra Extra Extra Small	287141008	287142008
Extra Extra Small	287141009	287142009
Extra Small	287141010	287142010
Small	287141011	287142011
Medium	287141012	287142012
Large	287141013	287142013

Extra Strap

Size (Bilateral)	Product Code
Extra Extra Extra Small - Extra Small	287130009
Small - Large	287130012

MCP Wedge

Size (Bilateral)	Product Code	MCP Width	Wrist to Finger Tip
Extra Extra Small	287110009	65mm	10mm
Extra Small	287110011	75mm	15mm
Large	287110013	90mm	20mm

Finger Divider

Size (Bilateral)	Product Code
Paediatric	287120003
Medium	287120005
Large	287120007

Ossur SoftPro® Functional Resting WHFO Available direct from Sheffield stock

- Color coded straps
- Extra long wrist strap holds the wrist in the proper position and applies a gentle stretch
- "Bend to Fit" – easily adjust to correct alignment and support joints without the use of a heat gun
- Also available in paediatric sizing, see page 159



SoftPro® Functional Resting WHFO

Size	Left	Right	Width of MP Joint	Length
Small	SP31FFR-S-L	SP31FFR-S-R	6.5 - 7.5cm	23cm
Medium	SP31FFR-M-L	SP31FFR-M-R	7.5 - 9cm	25cm
Large	SP31FFR-L-L	SP31FFR-L-R	9 - 10cm	28cm

Promedics Functional Resting Splint

- A functional resting splint that available in two options:
 - Full Padded Cover:** Preformed plastic shell with fully removable padded cover and comfortable wide closure straps. Ideal for patients using the splint on a longer term basis and the fully padded cover offers excellent comfort and compliance to those patients that are very sensitive
 - Easy Liner:** Preformed plastic shell with a towel liner that is attached using hook and loop tabs. Supplied with two towel lined padded liners that can be easily removed and replaced. Removable straps can be positioned as required. This option is more suited to conditions that benefit from easily changeable liners such as burns or trauma and is also a lower cost option



Padded Liner

Functional Resting Splint - Padded Cover

Size	Left (Black)	Right (Black)	Wrist Circumference
Extra Small	JRS/12	JRS/22	11.5 - 13cm
Small	JRS/13	JRS/23	14 - 15cm
Medium	JRS/15	JRS/25	16.5 - 18cm
Large	JRS/17	JRS/27	20 - 21.5cm
Extra Large	JRS/18	JRS/28	23 - 24cm

Functional Resting Splint - Easy Liner

Size	Left (Black)	Right (Black)	Wrist Circumference
Extra Small	JRSE/12	JRSE/22	11.5 - 13cm
Small	JRSE/13	JRSE/23	14 - 15cm
Medium	JRSE/15	JRSE/25	16.5 - 18cm
Large	JRSE/17	JRSE/27	20 - 21.5cm
Extra Large	JRSE/18	JRSE/28	23 - 24cm

Promedics Carpotec™ Carpal Brace

- Malleable aluminium frame covered with perforated breathable material
- Stabilises the wrist, hand and fingers
- Removable finger spaces
- Soft, padded straps
- Easily be adapted to the size of the wrist and thumb of the patient
- Anatomical shape provides comfortable and effective therapy



Removable finger spaces

Carpotec™ Carpal Brace

Size	Left	Right	Wrist Diameter
Extra Small	COT/12	COT/22	up to 7cm
Small	COT/13	COT/23	7 - 8cm
Medium	COT/15	COT/25	8 - 9cm
Large	COT/17	COT/27	9cm +

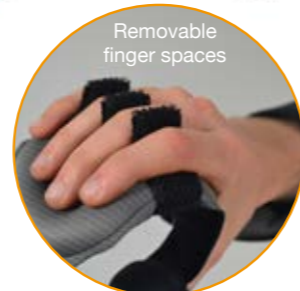

Restorative Medical BendEase

- Provides moderate, comfortable, padded and lightweight support
- Foam over aluminum base can be remoulded by hand
- Base extends under the thumb gradually abducting it comfortably
- Comfortable thumb support for mild lost range
- Includes optional and removable finger separators

Restorative Medical BendEase - Size

Size	Product Code Left	Product Code Right	Width of MCP	Wrist to Finger Measurement
Small	RM0056	RM0058	Up to 7.5cm	Up to 16.5cm
Medium	RM0060	RM0062	Up to 9cm	Up to 18cm
Large	RM0064	RM0066	Up to 9.5cm	Up to 20cm

Restorative Medical BendEase - Universal

Size	Product Code	Repl Soft Goods RM BendEase Size	Product Code
Universal Left	RM0052	Universal Left	RM0052-R
Universal Right	RM0054	Universal Right	RM0054-R



Restorative Medical BendEase - Sized



Restorative Medical BendEase - Universal

Restorative™ Hand

- High-temperature, remouldable plastic base
- Lightweight, padded support
- Plastic base extends under the thumb for gradual, comfortable abduction
- Flex Technology splint moves with the patient's abnormal muscle tone and spasticity
- Colour coding aids proper strap attachment
- Comfortable thumb support for mild lost range of motion
- Includes optional and removable finger separators



Restorative™ Hand

Size	Product Code Left	Product Code Right	Width of MCP	Wrist to Finger Measurement
Extra Small	RM0112	RM0114	7 - 7.5cm	Up to 12.5
Small	RM0116	RM0118	Up to 7.5cm	Up to 16.5cm
Medium	RM0120	RM0122	Up to 9cm	Up to 18cm
Large	RM0124	RM0126	Up to 9.5cm	Up to 20cm

Restorative Cock-up Wrist Splint

- High-temperature, remouldable plastic base
- Soft strap protects the thumb web space and secures the hand
- Wide, soft wrist strap holds the wrist at the cock-up position
- Thermal adaptive fabric helps to keep the hand cool and dry
- Wide straps provide comfort even during sleep



Restorative Cock-up Wrist Splint

Size	Product Code Left	Product Code Right	Width of MCP	Wrist to Finger Measurement
Extra Small	RM0300	RM0301	7 - 7.5cm	Up to 12.5
Small	RM0302	RM0303	Up to 7.5cm	Up to 16.5cm
Medium	RM0304	RM0305	Up to 9cm	Up to 18cm
Large	RM0306	RM0307	Up to 9.5cm	Up to 20cm

Neuroflex® Restorative Flex Hand

- Addresses tightest closed fist to moderate finger extension with graduated size cones, reverse cones or cylinders
- Includes sized cones that allow a gradual increase of the hand/finger's range of motion. Reverse cones and cylinders (rolls) are available upon request
- Thin palmar bar fits into the most tightly closed, fist hand
- Flex Technology splint moves with the patient's abnormal muscle tone and spasticity
- Padded with a high-temperature, remouldable plastic base



Neuroflex® Restorative Flex Hand

Size	Product Code Left	Product Code Right
Universal - Regular Cone	RM0100	RM0102
Universal - Reverse Cone	RM0159	RM0157
Universal - Cylinder	RM0161	RM0163

Neuroflex® Restorative Flex Hand - Soft Goods

Size	Product Code Left	Product Code Right
Universal	RM0100-R	RM0102-R

Promedics Isotoner® Therapeutic Gloves

- Available in open finger or full finger options
- Smooth stretch fabric provides gentle, even compression to help ease pain and prevent edema
- Made of 80% nylon and 20% Spandex - latex free
- Open finger design offers improved mobility
- All seams are on the outside of the glove for smooth comfort
- Area around base of the thumb is free of seams
- Provides moderate compression of approximately 23 to 32mm Hg pressure
- Gloves are sized unisex for both men and women
- Sold in pairs



Isotoner® Therapeutic Gloves

Size	Product Code - Open Finger	Product Code - Full Finger	Circumference at MP Joints
Extra Small	25830XS	25833XS	11 - 14cm
Small	25830S	25833S	14 - 17cm
Medium	25830M	25833M	17 - 19cm
Large	25830L	25833L	19 - 22cm

Restorative Accessories



Dorsal Interphalangeal Flex Assist



Infinity Dorsal Attachment



Ulnar Drift Finger Separators



Ulnar Drift Strapping

Restorative Accessories

Description	Size	Product Code
Interphalangeal Flex Assist	One Size	RM0260
Ulnar Drift Finger Separators	One Size	RM0266
Infinity Dorsal Attachment	Small	RM0261
Infinity Dorsal Attachment	Medium	RM0262
Infinity Dorsal Attachment	Large	RM0263
Ulnar Drift Strapping	One Size	RM0268
NeuroFlex RM Velcro-on Finger Separators	One Size	RM0265

Ossur Rebound® Post-Op Elbow

- Designed to be the most lightweight brace on the market
- Telescoping paddles relocate to individualise length and keep incision sites clear
- Intuitive patient touchpoints, including Blue is You™ buckles and numbered strapping system
- Drop-Lock hinge enables secure range of movement with bump-resistant pull adjustment stops and optional ROM lock-outs
- Mouldable stability cuffs designed to be individually customised for improved fit and support



Ossur Rebound® Post-Op Elbow

Size	Product Code Left	Product Code Right
Universal	B-8391680	B-8391580

Accessories	Product Code
Bar Kit	B-8390003
Soft Goods Universal	B-8390002

Promedics Ascender® Telescopic ROM Elbow Brace

- Low profile and lightweight design
- Secure and ergonomic design
- High grade anodised aluminium humeral and forearm bars
- Adjustable length at the touch of a button
- Custom fit and support - designed for comfort
- Optimised for airflow
- Silicone for ultra grip
- Quick clip range of motion control
- Lock ROM hinge at any angle setting



Ascender® Telescopic ROM Elbow Brace

Left	Right
ASCE/L/REG	ASCE/R/REG

Turtlebrace Elbow

- 'Apply and forget' type brace made of a stratification of multi perforated low-temperature thermoplastic and microfibre fabric
- Flexibility of components stabilises joint more easily and precisely than a traditional brace or cast
- Can be reshaped multiple times, without losing its qualities - allows adjustment due to swelling or morphological changes



Turtlebrace Elbow

Age/Size	Product Code	Arm Circumference	Wrist Circumference	Total Length
Adult - Small	TBCOA-01	Min: 21.7cm Max: 27.6cm	Min: 14cm Max: 17.6cm	43.4cm
Adult - Medium	TBCOA-02	Min: 26.1cm Max: 33.3cm	Min: 14.4cm Max: 18.1cm	43.7cm
Adult - Large	TBCOA-03	Min: 32.4cm Max: 41.5cm	Min: 16.2cm Max: 20.5cm	44.1cm



Promedics Cubital Tunnel Splint

- Universal, easy to fit splint
- Effectively restricts elbow flexion to help reduce the pain associated with Cubital Tunnel Syndrome
- Soft padded wrap with an adjustable aluminium stay
- Easy to apply, lightweight and breathable



Cubital Tunnel Splint

Product Code	Size
CTS/10	Universal

Promedics Clasp Splint

- Designed to reduce the pain and discomfort associated with elbow tendinopathies, conditions more commonly referred to as epicondylitis, tennis or golfer elbow
- Contains latex



Clasp Splint

Size	Product Code	Arm Circumference
Extra Small	JRC/02	22 - 23cm
Small	JRC/03	24 - 25cm
Medium	JRC/05	26 - 27cm
Large	JRC/07	28 - 30cm
Extra Large	JRC/08	31 - 34cm

Promedics Standard Humeral Fracture Brace

- Polypropylene humeral sleeve with closed cell foam lining
- Polythene insert for comfort and improved fit
- Sleeve can be cut with bandage shears and is heat mouldable
- Kit includes two humeral cast socks and a fully adjustable sling



Standard Humeral Fracture Brace

Size	Product Code (Full Kit)	Product Code (Sleeve Only)	Length	Circumference of upper arm	
				Distal	Proximal
Small	SHC/03	SHS/03	15cm	18 - 23cm	23 - 28cm
Medium	SHC/05	SHS/05	17cm	23 - 28cm	28 - 33cm
Large	SHC/07	SHS/07	18cm	28 - 33cm	33 - 38cm
Extra Large	SHC/08	SHS/08	23cm	33 - 38cm	38 - 43cm

Promedics Clavicle Splint

- Soft padded shoulder straps with return loops and padded back pad
- Comfort pads can be positioned anywhere along the length of the straps – for example in the axilla area
- Straps can be easily trimmed to length and refastened using the hook Y-tab closures.



Clavicle Splint

Product Code	Size
JCS/10	Universal

Beagle Orthomerica Humeral Extended Fracture Brace

- Extended functional brace indicated for closed diaphyseal fractures
- Shoulder cap design limits distal brace migration giving greater protection and compliance
- Easily trimmed for optimum fit and to allow for a range of motion in the elbow
- Adjustable hook and loop straps maintain the desired compression
- Universal left and right
- Item includes: 1 fracture brace, 2 fracture socks



Beagle Orthomerica Humeral Extended Fracture Brace

Size	Product Code	Circumference of upper arm	
		Distal	Proximal
Extra Small	B/1089	15 - 20cm	20 - 25cm
Small	B/1090	20 - 25cm	23 - 28cm
Medium	B/1091	25 - 28cm	28 - 33cm
Large	B/1092	28 - 33cm	33 - 38cm
Extra Large	B/1093	33 - 38cm	38 - 43cm

Promedics Subluxation Cuff

- Humeral cuff with soft cotton lining supports the injured arm
- Padded webbing strap fits under the opposite axilla
- Universal design fits right and left arm



Subluxation Cuff

Size	Product Code	Mid Upper Arm Circumference
Small	SCF/03	24 - 29cm
Medium	SCF/05	29 - 34cm
Large	SCF/07	34 - 40cm

Beagle Universal Clasby Humeral Brace

- Chest strap distributes weight across the body without impinging on the breast area, especially in females
- Provides mild abduction to control and manage pain
- Easy to apply for enhanced compliance
- 6 easy to remove metal stays exert pressure equally to stabilise the fracture
- Trimmable around the elbow for a more customised fit
- 2 dual pull compression straps apply compression and prevent rotation
- Extension piece provided to accommodate oedema



Beagle Universal Clasby Humeral Brace - Metal Stays

Size	Product Code	AC Joint to Elbow (mm)
Extra Small	UBC/12	28cm
Small	UBC/13	30cm
Medium	UBC/15	32cm
Large	UBC/17	34cm
Extra Large	UBC/18	35cm

Promedics Neoprene Shoulder Brace

- Two adjustable upper arm cuffs fix with hook and loop at the back of the neck
- Prevents shoulder subluxation and holds the head of humerus in the glenoid cavity



Neoprene Shoulder Brace

Size	Product Code	Mid Upper Arm Circumference
Small	NSB/03	23 - 28cm
Medium	NSB/05	28 - 33cm
Large	NSB/07	33 - 38cm
Extra Large	NSB/08	38 - 43cm

Beagle Neuro-Lux® Shoulder II

- Significant correction of the pathological internal rotation by enclosing the elbow and correspondingly external rotatory diagonal rein guidance
- Reduction of the humeral head in the shoulder joint with correction of subluxation and internal rotation
- Pain relief
- Secures the shoulder joint with free arm function
- Improved gait pattern through arm pendulum movement
- Avoidance of secondary damage to the capsule, tendons, muscles and nerves due to traction
- Easily adjustable arm element features flat contact and nubbed tape, and can be closed with one hand
- Easy to use chest strap



Beagle Neuro-Lux® Shoulder II

Size	Left	Right	Circumference of Lower Arm (mm)	Chest Circumference (mm)
1	07261/1L	07261/1R	210 - 250	750 - 900
2	07261/2L	07261/2R	210 - 250	900 - 1050
3	07261/3L	07261/3R	210 - 250	1050 - 1250
4	07261/4L	07261/4R	250 - 290	750 - 900
5	07261/5L	07261/5R	250 - 290	900 - 1050
6	07261/6L	07261/6R	250 - 290	1050 - 1250
7	07261/7L	07261/7R	290 - 350	750 - 900
8	07261/8L	07261/8R	290 - 350	900 - 1050
9	07261/9L	07261/9R	290 - 350	1050 - 1250

Promedics Bradford Arm Elevator Sling

- Made in hook and loop attractive foam
- Supports the forearm and upper arm close to the body, using the shoulder strap and body strap
- Strap extending from the wrist section includes a D-ring which can be attached to a drip stand to allow arm elevation
- Universal design fits left and right arm



Bradford Arm Elevator Sling

Size	Product Code	Depth x Length
One Size	AESB/10	28 x 43cm

Promedics Sling and Swathe

- Simple padded sling supports the arm
- Webbing shoulder straps cross at the back hold the arm in position
- Adjustable body binder holds the upper arm close to the body for increased shoulder stability
- Universal design fits right and left arm



Sling and Swathe

Size	Product Code	Body Binder	Padded Sling
Small	SSW/03	13 x 41cm	20 x 28cm
Medium	SSW/05	13 x 94cm	23 x 31cm
Large	SSW/07	15 x 119cm	25 x 33cm

Promedics Lancaster Shoulder Sling

- Padded, non-stretch straps
- Fast release buckles
- Y-tab adjustments
- Fold lines



Promedics Lancaster Shoulder Sling

Size	Product Code
Universal	LSS/10

Promedics Trauma Sling

- High quality universal sling
- Can be used as a traditional sling or for post-operative management of the shoulder or upper arm. The design and quality of materials used
- Offers protection, comfort and ease of access to the damaged limb
- Easy to apply and is supplied vacuum packed to reduce storage volume



Promedics Trauma Sling

Size	Product Code
Universal	TAU/10

Promedics Shoulder Immobiliser

- Can be used as an arm sling or as a shoulder immobiliser
- Designed to be used on both left and right arms
- Strong cotton sling with fully adjustable padded shoulder and body straps



Shoulder Immobiliser

Size	Product Code	Forearm Length
Extra Small	JSI/02	< 33cm
Small	JSI/03	33 - 38cm
Medium	JSI/05	37 - 43cm
Large	JSI/07	42 - 48cm
Extra Large	JSI/08	48cm >

Promedics Jura Abduction Sling

- Three-point offloading harness that offers excellent support and comfort
- Lightweight breathable 3D spacer fabric, attaches to the abduction pads
- Fitted with easy release buckles
- Supplied with a contoured 15° pad that can be used on its own
- An additional pad increases abduction to 45° and positions the shoulder in a neutral position
- Detachable exercise ball also provided



Jura Abduction Sling

Size	Product Code	Forearm Length
Small	JASS/03	38cm
Medium	JASS/05	40cm
Large	JASS/07	43cm
Extra Large	JASS/08	46cm

Promedics Shoulder Lock

- Universal fast-fit low profile shoulder immobiliser
- Comes complete with a body wrap, to which the upper arm wrap is secured to effectively immobilise the shoulder
- Wrist wrap fixes to the anterior of the body wrap, which in turn is secured to the shoulder strap using a fast-fit snap buckle
- Shoulder strap can be adjusted posteriorly to achieve a comfortable fit for the patient and also to alter the brace to fit left or right
- Large comfort pad distributes pressure over the shoulder/clavicle
- Easy to fit, modular design greatly improves patient compliance



Shoulder Lock

Product Code	Size
JSL/10	Universal







Spinal Supports







Promedics Aspen Spine Application

C1-C7

<p>Decompressive procedures Fracture management Cervicogenic headache Cervical disc syndrome Postsurgical stabilization</p>  <p>Aspen Vista- Collar</p>	<p>Musculoskeletal pain Trauma / whiplash Sprains / strains Radiculopathy</p>  <p>Aspen Vista- TX Collar</p>
 <p>Aspen Collar</p>	 <p>Aspen Pediatric Collar</p>
<p>Cervicogenic headaches Decreased range of motion Radiculopathy Neuropathy Stiff neck</p>  <p>Aspen Vista- MultiPost Therapy Collar</p>	<p>General neck pain Muscle spasms Thoracic pain Whiplash</p>

T9-S1

<p>Postoperative support / pain relief Kyphosis secondary to osteoporosis Decompressive procedures Degenerative disc disease Bulging or herniated disc</p>  <p>Aspen Vista- 464 TLSO</p>	<p>Fracture management Spondylolisthesis Spinal stenosis Spondylosis Severe DJD</p>  <p>Aspen Summit- 456 TLSO</p>
 <p>Aspen Horizon- 456 TLSO</p>	 <p>Aspen Sierra- TLSO 464</p>

SI-S5

<p>Symphysis pubis dysfunction Sacroiliac joint dysfunction Chronic sacroiliac support Sacroiliac joint fusion Fracture management Sprains / strains</p>  <p>Aspen Evergreen- 621 SI Belt</p>	<p>Piriformis syndrome Pelvic muscle pain Sacroiliac pain Low back pain Arthritis Sciatica</p>
--	--

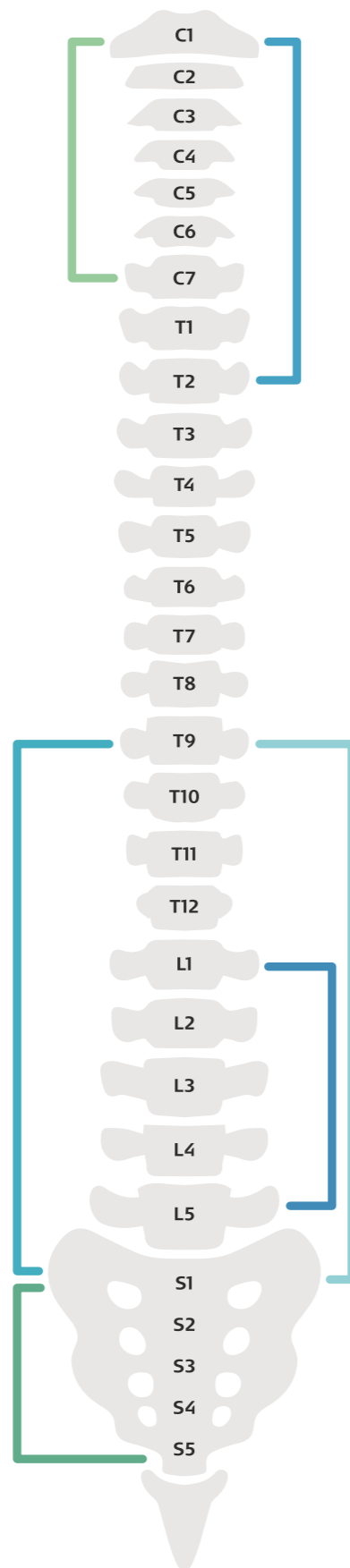

C1-T2

Postsurgical stabilization Cervicothoracic instability Fracture management



Aspen Vista- CT04
Aspen Vista- CT0

Aspen- CT0
Aspen- Pediatric CT0

SCOLIOSIS

Adult scoliosis with postural, pain or quality of life issues



Aspen Tri-Point FSO

T9-S1

<p>Postoperative support / pain relief Deconditioned trunk musculature Post laminectomy syndrome Decompressive procedures Degenerative disc disease Bulging or herniated disc Insidious low back pain Chronic low back pain Fracture management Spondylolisthesis</p>  <p>Aspen Vista- 637 LSO Aspen Vista- 631 LSO LoPro</p>	<p>IDET procedure Spinal stenosis Sprains / strains Facet syndrome SI dysfunction Radiculopathy Spondylosis Severe DJD Sacrolitis Injections</p>  <p>Aspen Summit- 637 LSO Aspen Summit- 631 LSO</p>
 <p>Aspen Horizon- 637 LSO Aspen Horizon- 631 LSO</p>	 <p>Aspen Sierra- LSO 637</p>

L1-L5

<p>Postoperative support / pain relief Deconditioned trunk musculature Post laminectomy syndrome Decompressive procedures Degenerative disc disease Bulging or herniated disc Insidious low back pain Chronic low back pain Fracture management Spondylolisthesis</p>  <p>Aspen Horizon- 627 Lumbar</p>	<p>IDET procedure Spinal stenosis Sprains / strains Facet syndrome SI dysfunction Radiculopathy Spondylosis Severe DJD Sacrolitis Injections</p>  <p>Aspen QuikDraw- PRO Aspen Lumbar Support</p>
--	---

Promedics Aspen OTS TLSO

- One-size adjustable, inelastic spinal brace
- Low profile design
- Fits waists ranging from 71-137 cm and up to 188 cm with the extension panel



Promedics Aspen OTS TLSO

Product Code	Size
504573	Universal - 71cm - 137cm

Promedics Aspen Sierra Adjustable LSO and TLSO

- One size adjustable
- Fits waists ranging from 71-137 cm and up to 188 cm with the extension panel



Promedics Aspen Sierra

Product Code	Size	Description
501111	-	Aspen Sierra LSO Adjustable
501221	-	Aspen Sierra TLSO Adjustable
501322	51cm	Aspen Sierra Extension Panel Adjustable

Promedics Aspen Lumbar Support

- Simple, elegant design
- Two-stage relief
- Essential trunk stability
- Independent compression
- Tailored, comfortable fit
- Easy to locate pull tabs



Promedics Aspen Lumbar Support

Product Code	Size	Measurements
580101	Extra Small	53 - 69cm
580102	Small	66 - 79cm
580103	Medium	79 - 91cm
580104	Large	91 - 107cm
580105	Extra Large	104 - 122cm
580106	Extra Extra Large	109 - 132cm



Promedics Aspen Summit 637 LSO Adjustable

- Delivers targeted compression, motion restriction, and maximal comfort
- Anterior support
- Conforms to different anatomies
- Available in a one-size adjustable
- Fits waists ranging from 66-152 cm and up to 178 cm with the extension panel



Promedics Aspen Summit 637 LSO Adjustable

Size	Product Code
Universal	992310

Promedics Aspen Horizon® 631 LSO

- Low profile design
- SlickTrack™ tightening system provides essential trunk stability and targeted compression
- Available in a one-size adjustable - comfortably fits waist sizes ranging from 61-127cm, and up to 178cm with the extension panels
- Horizon braces can be stepped down to the Horizon PRO for treatment of recurring ailments



Aspen Horizon® 631 LSO LOPRO

Size	Product Code
Universal	993720

Promedics Aspen Summit 456 TLSO

- Versatile adjustable posterior support
- Thoracic to lumbar
- Comfortable - easy don and doff
- Available in a one-size adjustable
- Fits waists ranging from 66-152 cm and up to 178 cm with the extension panel



Promedics Aspen Summit 456 TLSO

Size	Product Code
Universal	992710

Promedics Aspen Horizon® 627 Lumbar

- Lowest profile design
- SlickTrack™ tightening system provides essential trunk stability and targeted compression
- Available in a one-size adjustable - comfortably fits waist sizes ranging from 61-127cm, and up to 178cm with the extension panels
- Horizon braces can be stepped down to the Horizon PRO for treatment of recurring ailments



Promedics Aspen Horizon® 627 Lumbar

Size	Product Code
Universal	993710

Promedics Aspen Evergreen 621 SI

- Bi-lateral pull system provides maximum compression without the rotational loading that can occur with a single pull tab system
- Low profile and lightweight design makes extended wear comfortable
- Sacral stabilization
- Bi-lateral pull
- Non-slip silicone strips



Promedics Aspen Evergreen 621 SI

Size	Product Code	Waist
Small	36-2102	64 - 104cm
Medium	36-2104	89 - 127cm
Large	36-2106	114 - 152cm

Promedics Aspen Horizon® 637 LSO

- Flexion and extension support with lateral control
- Integrated anterior support
- Available in a one-size adjustable - comfortably fits waist sizes ranging from 61-127cm, and up to 178cm with the extension panels
- Horizon braces can be stepped down to the Horizon PRO for treatment of recurring ailments



Promedics Aspen Horizon® 637 LSO

Size	Product Code
Universal	993730

Promedics Aspen Horizon® 456 TLSO

- Height adjustment technology
- Wide circumference range
- Comfortable - easy don and doff
- Available in a one-size adjustable - comfortably fits waist sizes ranging from 61-127cm, and up to 178cm with the extension panels
- Horizon braces can be stepped down to the Horizon PRO for treatment of recurring ailments



Promedics Aspen Horizon® 456 TLSO

Size	Product Code
Universal	993740

Promedics Aspen Horizon® Extension Panels

- Horizon® Extension Panels.
- Additional length - 51cm



Promedics Aspen Horizon® Extension Panels

Size	Product Code
Universal	993745

Promedics Aspen TLSO

- Versatile option that provides a high degree of motion restriction through the mid-thoracic region without compromising comfort
- This added support helps provide an enhanced environment for healing
- The Aspen TLSO can also be stepped down to the Aspen LSO



Promedics Aspen TLSO

Size	Product Code	Waist	Back Panel	Cut Out
Short/Small	991030	66cm - 99cm	33cm	20cm
Short/Large	991031	91cm - 124cm	33cm	20cm
Tall/Small	991070	81cm - 119cm	40cm	25cm
Tall/Large	991071	112cm - 150cm	40cm	25cm

Promedics Aspen TLSO - Replacement Pads

Size	Product Code
Short/Small	991035

Promedics Aspen LSO LoPro

- Low-profile lateral panels ("Low Profile")
- Provides targeted compression along with comfortable support
- LeverLatch™ mechanism provides motion restriction
- Unique, three-piece design featuring symmetrical side panels allows patients to easily tighten the brace with either hand while providing even compression throughout the tightening process



Promedics Aspen LSO LoPro

Size	Product Code	Waist	Back Panel	Cut Out
Small	990020	66 - 99cm	40cm	25cm
Large	990021	66 - 99cm	40cm	25cm
Short/Small	990040	91 - 124cm	40cm	25cm
Short/Large	990041	91 - 124cm	40cm	25cm
Tall/Small	990060	117 - 158cm	40cm	25cm
Tall/Large	990061	117 - 158cm	40cm	25cm



Promedics Aspen LSO LoPro - Replacement Pads

Size	Product Code
Small	990025

Promedics Aspen Tripoint FSO

- Acts as an unloader brace helping to restore a natural centre of gravity
- Aspen's patented pull-through sizing mechanism and highly visible size indicators allow for quick and easy adjustments
- Vertical stays provide stability and can be removed on smaller sizes for a low profile, comfortable fit



Promedics Aspen Tripoint FSO

Size	Product Code
Universal	591911

Promedics Aspen QuikDraw™ Pro

- Designed to help increase trunk stability and provide targeted compression
- SlickTrack™ tightening mechanism allows patients to easily control upper and lower compression
- Independent upper and lower tightening



Promedics Aspen QuikDraw™ Pro - Black

Size	Product Code	Circumference Waist
Small	993011	66cm - 81cm
Medium	993021	79cm - 94cm
Large	993031	91cm - 107cm
Extra Large	993041	104cm - 119cm

Promedics Aspen Quikdraw™ Pro - Extension Panel, Black

Promedics Aspen QuikDraw™ Pro - Rigid Anterior Panel Black

Size	Product Code
Regular	993200
Large	993201



Promedics Aspen Vista® 464 TLSO

- Unique Sure Slot™ System mechanism allows for quick and easy adjustment without the need for tools
- Adjusts from 33-53cm in height
- Three shoulder strap configurations
- Removable panels include designated trim lines for ease of customisation
- Vista® braces can be easily stepped down to accommodate the required support and motion restriction
- Super SlickTrack™ System features independent upper and lower tightening mechanisms
- Fits waist sizes ranging from 66-152cm, and up to 178cm with the extension panel



Vista® 464 TLSO

Product Code	Size
993640	66cm - 152cm

Promedics MP45 Plus 3-Point Hyperextension Brace

- Lightweight aluminium construction with unique spring-loaded 'floating' pelvic band
- Thorocolumbar pad can be positioned horizontally or vertically
- Unique 'Plus-lock' closure ensures controlled posterior loading
- Sternal component can be adjusted without bending, using serrated disc for angular adjustments in 5° settings



MP45 Plus 3-Point Hyperextension Brace

Size	Product Code	Pelvic Circumference	Height from Centre of Sternal Pad to Centre of Pelvic Strip
Small	TO1303N/S	60 - 75cm	31 - 42cm
Medium	TO1303N/M	75 - 90cm	35 - 46cm
Large	TO1303N/L	90 - 105cm	42 - 50cm
Extra Large	TO1303N/XL	105 - 120cm	42 - 50cm

Promedics Nhyco Cruciform Hyperextension Orthosis

- A strong, lightweight aluminium alloy frame brace
- Weighs less than 700g
- Replaceable EVA padding is non toxic, waterproof and latex-free
- Features new 'Plus' safety lock closure system for ease of patient application/removal and ensures the same lumbar pressure each time



Nhyco Cruciform Hyperextension Orthosis

Size	Product Code
Short	TO410CS
Regular	TO410CR
Long	TO410CL

Promedics Pro Tem Belt

- Simple but effective belt made using high quality elastic and two flexible posterior stays
- Quality Lycra bound edges
- Back depth of 20cm cut away to 18cm at the front for increased comfort when sitting

Pro Tem Belt

Size	Product Code	Waist Measurement
Small	TB/03	66 - 74 cm
Medium	TB/05	76 - 84 cm
Large	TB/07	86 - 94 cm
Extra Large	TB/08	96 - 104 cm
Extra Extra Large	TB/09	107 - 114 cm

Also available in paediatric sizing, see page 161.



Promedics TLSO Back Brace

- Provides full-circumferential rigid support from the T2/T3 scapular thoracic region to the sacrococcygeal junction
- Features rigid anterior and posterior panels, a telescoping sternal aluminum Y-Bar and dual lacer compression pads
- Easy application with dual side pulls
- Even, progressive compression from proprietary teardrop Lacer Compression System
- Breathable Airmesh liner for maximum comfort
- Midline opening in posterior panel eases pressure over the incision site, allowing for wound inspection without removing the orthosis
- Heat moldable panels

TLSO Back Brace

Product Code	Size	Circumference Waist
60002/B	Small	64 - 76cm
60003	Medium	76 - 89cm
60004	Large	89 - 107cm
60005	Extra Large	107 - 122cm
60006	Extra Extra Large	122 - 145cm



Promedics Proform Belt

- Elastic front with hook and loop closure with a cotton back section
- Detachable comfort pad and two malleable steels, which can be shaped to fit the spinal curve
- The webbing strap can be positioned in the lumbar or sacral area for extra compression on the spinal curve
- Back depth is 28cm to support the thoracic area, reducing to 20cm at the front for comfort
- **Contains latex**

Proform Belt

Size	Product Code	Waist Measurement
Small	PFM/83	58 - 66cm
Medium	PFM/85	68 - 76cm
Large	PFM/87	79 - 86cm
Extra Large	PFM/88	89 - 97cm
Extra Extra Large	PFM/89	99 - 107cm



Promedics Sacro Lumbar Support

- To accommodate the waist/hip differential, two layers of elastic are sewn at an angle giving this belt increased strength and good conformity
- Back depth 23cm, front dept 18cm
- Posterior pocket lined with Neoprene for extra comfort and warmth
- Flexible panel (FPP/8) or a thermoplastic panel (TPP/8) can be supplied separately if required
- **Contains latex**



Sacro Lumbar Support

Size	Product Code	Waist Measurement
Small	BLASLS/03	64 - 74cm
Medium	BLASLS/05	76 - 84cm
Large	BLASLS/07	86 - 94cm
Extra Large	BLASLS/08	96 - 104cm

Promedics Tag+ Dorsolumbar Corset Available direct from Sheffield stock

- A rigid corset with frame and integrated flexible splints
- Elastic strap system uses a pulley system to converge into a single strap
- Provides variable pressure and a simple but effective traction
- Oblique splints strengthen the abdominal area
- Reverse shoulder straps allow greater antero-posterior thrust of the shoulders
- Front height: 17cm - Back height: 55cm



Tag+ Dorsolumbar Corset - Anthracite Grey

Size	Product Code	Widest Point of Hips
Small	TO1310/S	80 - 90cm
Medium	TO1310/M	90 - 100cm
Large	TO1310/L	100 - 110cm
Extra Large	TO1310/XL	110 - 120cm
Extra Extra Large	TO1310/XXL	120 - 130cm

Trulife PT137 Platinum Thoracolumbar Orthosis

- Adjustable, discreet thoracic, lumbar, sacral and abdominal support
- Stays and boning provide additional back support
- Antibacterial Trutex fabric promotes freshness
- Breathable stretch foam
- Back height: 26cm - Front height: 23cm



Trulife PT137 Platinum Thoracolumbar Orthosis

Size	Product Code	Hip Circumference
Small	PT13702	75-85cm
Medium	PT13703	85-95cm
Large	PT13704	95-105.5cm
Extra Large	PT13705	105.5-115.5cm
Extra Extra Large	PT13706	115.5-126cm

Promedics Proflex Belt

- Hook and loop fastening elastic belt, with an elastic back pocket to accommodate a panel
- Available with a choice of back panels
- Cotton fulcrum strap can be positioned in the lumbar or sacral area from extra compression on the spine
- Front depth is 20cm
- **Contains latex**



Proflex Belt (No Panel) - 20cm Back Depth

Size	Product Code	Waist Measurement
Small	PFN/83	64 - 76cm
Medium	PFN/85	79 - 89cm
Large	PFN/87	89 - 99cm
Extra Large	PFN/88	99 - 109cm
Extra Extra Large	PFN/89	109 - 119cm

Proflex Belt (Flexible Panel) - 20cm Back Depth

The back pocket encloses a panel of polythene lined with closed cell foam, which becomes flexible with body heat.

Size	Product Code	Waist Measurement
Small	PF/83	64 - 76cm
Medium	PF/85	79 - 89cm
Large	PF/87	89 - 99cm
Extra Large	PF/88	99 - 109cm
Extra Extra Large	PF/89	109 - 119cm

Promedics Lumbarform Belt

- Triple elastic fulcrum straps at the back attach to one simple strap at the front, giving extra compression on the spinal curve
- Two flexible stays keep the belts smooth at the front for comfort when sitting
- Ventilated elastic which has Lycra binding to prevent chafing.
- Available with a choice of back panels and stays
- **Contains latex**



Standard Lumbarform Belt (Flexible Panel) - 23cm Back Depth

The double-layer back pocket encloses a panel of polythene lined with closed cell foam, which becomes flexible with body heat.

Size	Product Code	Waist Measurement
Small	LBF/93	69 - 76cm
Medium	LBF/95	79 - 86cm
Large	LBF/97	89 - 97cm
Extra Large	LBF/98	99 - 107cm

Lumbarform Belt with Stays - 23cm Back Depth

Two flexible posterior stays and a double-layer ventilated elastic back pocket stabilise the spine.

Size	Product Code	Waist Measurement
Small	LBS/93	69 - 76cm
Medium	LBS/95	79 - 86cm
Large	LBS/97	89 - 97cm
Extra Large	LBS/98	99 - 107cm

Deep Lumbarform Belt (Flexible Panel) - 31cm Back Depth

The double-layer back pocket encloses a panel of polythene lined with closed cell foam, which becomes flexible with body heat.

Size	Product Code	Waist Measurement
Small	LBF/123	69 - 76cm
Medium	LBF/125	79 - 86cm
Large	LBF/127	89 - 97cm
Extra Large	LBF/128	99 - 107cm

Thuasne Sleeq® Max TLSO

- Strong immobilisation: rigid tri-planar control with full circumference shell design, reinforced panels and steel components
- Customisable: anterior panels can be trimmed or heat moulded for anatomic fit and adjustable sternal bar
- Adjustable design: steps down to LSO to evolve with patient's condition
- Comfort: ventilated components and anatomically moulded back panel
- Ease of use: lacing system with easy-grip handles and practical straps with snap and release buckles
- Universal size

Thuasne Sleeq® Max TLSO

Size	Product Code
Universal	U50401007001



Thuasne Sleeq® Flex

- Immobilisation: semi-rigid structure provides support
- Comfort: ventilated self-moulding support panels
- Ease of use: lacing system with easy-grip handles
- Universal size: easily adjustable to fit waist sizes 65 - 145 cm
- Adjustable design: additional extension panel accommodates waist sizes 145 - 165 cm

Thuasne Sleeq® Flex

Size	Product Code
Universal	T54660399902799



Thuasne Boa Duel TLSO

- Full-circumferential rigid support for the thoracolumbar spine
- Patentend Lacer Design Compression System
- Simple pull straps for easy tightening and adjustment

Thuasne Boa Duel TLSO

Size	Product Code
S	U5030120299999
M	U5030120399999
L	U5030120499999
XL	U5030120599999
XXL	U5030120699999



Thuasne Lombastab High Lumbar Belt

- Easy and precise tightening: wire lacing system with easy-grip handles
- Adapts to the anatomy: 4 conformable dorsal stays and independent back plates
- Ease of application: symmetrical hand loops to ensure lumbar support is properly centred on the spine
- Comfort: specific Lombastab elastic fabric with breathable Coolmax lining
- Easy care: machine washable at 30°C
- Available in 35cm or 40 cm height

Thuasne Lombastab High

Size	Product Code 35cm High	Product Code 40cm High	Waist Circumference
1	08550120109899	08560120109899	60 - 80cm
2	08550120209899	08560120209899	75 - 95cm
3	08550120309899	08560120309899	90 - 110cm
4	08550120409899	08560120409899	105 - 125cm
5	08550120509899	08560120509899	120 - 140cm



Thuasne Lombaskin Lumber

- Lightweight, discreet lumbar support
- Seamless design provides a second skin effect
- Can be worn all day long, thanks to the Combitec fabric
- 4 anatomical stays in the posterior part and 2 flexible stays in the abdominal section
- Easy care: machine washable at 30°C
- Available in 21 cm or 26cm height

Thuasne Lombaskin Lumber

Size	Product Code 21cm High	Product Code 26cm High	Waist Circumference
1	08710320109899	08700320109899	60 - 80cm
2	08710320209899	08700320209899	75 - 95cm
3	08710320309899	08700320309899	90 - 110cm
4	08710320409899	08700320409899	105 - 125cm
5	08710320509899	08700320509899	120 - 140cm



Thuasne Dynabelt

- Breathable, comfortable and moisture-evacuating patented Combitec fabric
- Removable, flexible abdominal and dorsal stays
- Ease of application with self-fastening closure with thumb loops
- Can be sterilized in autoclave, machine washable at 60°C

Thuasne Dynabelt - White

Size	Product Code 16cm High	Product Code 26cm High	Product Code 33cm High	Waist Circumference
1	70100720100099	70100820100099	70100920100099	60 - 80cm
2	70100720200099	70100820200099	70100920200099	75 - 95cm
3	70100720300099	70100820300099	70100920300099	90 - 110cm
4	70100720400099	70100820400099	70100920400099	105 - 125cm
5	70100720500099	70100820500099	70100920500099	120 - 140cm
6	-	-	70100920600099	141 cm - 160 cm



Thuasne Lombastab Dorso

- Easy and precise tightening: wire lacing system with easy-grip handles.
- Height-adjustable back straightener (from 36 cm to 61 cm) adapts to patient size
- Hyperextension achieved by back frame, sternal support and shoulder straps
- Symmetrical hand loops to ensure lumbar support is properly centred on the spine
- Lombastab elastic fabric with comfortable and breathable Coolmax lining
- S-shaped and padded shoulder straps prevent armpit friction
- Easy care: machine washable at 30°C

Thuasne Lombastab Dorso

Size	Product Code	Waist Circumference
1	08470120109899	60 - 80cm
2	08470120209899	75 - 95cm
3	08470120309899	90 - 110cm
4	08470120409899	105 - 125cm
5	08470120509899	120 - 14cm



Medi Spinomed

- Scientifically proven efficacy
- Strengthens the core musculature
- Innovative pivot joint activates back muscles through biofeedback
- Straightens the upper body by strengthening muscle power with reduction of osteoporosis-related kyphosis

Medi Spinomed

Size	Product Code	Back Length
XS	857/1	Up to 42cm
S	857/2	41 - 48cm
M	857/3	47 - 54cm
L	857/4	53 - 60cm
XL	857/5	59 - 66cm



Orthotix Orliman Reinforced Lumbar Support Belt - Lumbitron Forte

- High lumbosacral back support featuring two tensor elastic bands that cross at the rear and fasten to the front
- Breathable multiband fabric
- Removable foam lumbar plate for the provision of heat to the area

Orthotix Orliman Reinforced Lumbar Support Belt - Lumbitron Forte

Size	Product Code	Widest Point of Hips	Front Height	Back Height
1	LT-300/1	63 - 75cm	16cm	6cm
2	LT-300/2	75 - 83cm	16cm	6cm
3	LT-300/3	83 - 91cm	16cm	6cm
4	LT-300/4	91 - 99cm	16cm	6cm
5	LT-300/5	99 - 107cm	16cm	6cm
6	LT-300/6	107 - 115cm	16cm	6cm
7	LT-300/7	115 - 123cm	16cm	6cm



Brace Orthopaedic MKS® Body Belt

- Semi-elastic bandaging material
- Lateral reinforcing stays
- Firm abdominal piece with hook and loop fastener
- Back pocket to accommodate modular back plate



MKS® Body Belt

Size	Product Code	Body Circumference	Anterior Depth of Belt	Posterior Depth of Belt
1	582-001-S	60 - 70cm	18cm	22cm
2	582-002-S	70 - 80cm	18cm	23cm
3	582-003-S	80 - 90cm	18cm	23cm
4	582-004-S	90 - 105cm	18cm	24cm
5	582-005-S	105 - 120cm	18cm	24cm
6	582-006-S	120 - 135cm	18cm	24cm

Brace Orthopaedic MKS® Body Belt Plus

- Semi-elastic bandaging material
- Lateral reinforcing stays
- Firm abdominal piece with hook and loop fastener
- Back pocket to accommodate modular back plate.
- Additional tensioning straps



MKS® Body Belt Plus

Size	Product Code	Body Circumference	Anterior Depth of Belt	Posterior Depth of Belt
1	582-201-S	60 - 70cm	18cm	22cm
2	582-202-S	70 - 80cm	18cm	23cm
3	582-203-S	80 - 90cm	18cm	23cm
4	582-204-S	90 - 105cm	18cm	24cm
5	582-205-S	105 - 120cm	18cm	24cm
6	582-206-S	120 - 135cm	18cm	24cm

Brace Orthopaedic MKS® Pontsana®

- Semi-elastic bandaging material
- Firm abdominal piece with hook and loop fastener
- Lateral reinforcing stays and spring band steel bridging rods
- Additional lateral double straps



MKS® Pontsana®

Size	Product Code	Body Circumference	Anterior Depth of Belt	Posterior Depth of Belt
1	582-801-S	60 - 70cm	18cm	32cm
2	582-802-S	70 - 80cm	18cm	32cm
3	582-803-S	80 - 90cm	18cm	34cm
4	582-804-S	90 - 105cm	18cm	34cm
5	582-805-S	105 - 120cm	18cm	38cm
6	582-806-S	120 - 135cm	18cm	38cm
51	582-8051-S	105 - 120cm	18cm	34cm (reduced)
61	582-8061-S	120 - 135cm	18cm	34cm (reduced)

Brace Orthopaedic MKS® Pontsana® Plus

- Semi-elastic bandaging material
- Firm, circular high abdominal piece with hook and loop fastener
- Lateral reinforcing stays and spring band steel bridging rods
- Additional lateral double straps



MKS® Pontsana® Plus

Size	Anterior Depth of Belt 25cm Posterior Depth of Belt 32cm	Anterior Depth of Belt 30cm Posterior Depth of Belt 38cm	Body Circumference
1	582-9011-S	582-9012-S	60 - 70cm
2	582-9021-S	582-9022-S	70 - 80cm
3	582-9031-S	582-9032-S	80 - 90cm
4	582-9041-S	582-9042-S	90 - 105cm
5	582-9051-S	582-9052-S	105 - 120cm
6	582-9061-S	582-9062-S	120 - 135cm

Brace Orthopaedic MKS® Osteo Flex

- Semi-elastic bandaging material with lateral reinforcing stays
- Firm abdominal piece with hook and loop fastener
- Textile back piece with paravertebral steel tape rods
- Adjustable back plate with incorporated aluminium profile
- Reclination straps
- Individual strap course



Body Belt + Osteo Flex Back Plate = Osteo Flex. To make a modular Osteo Flex TLSO solution please choose the appropriate belt and back plate options from the following charts.

MKS® Osteo Flex

Size	Product Code	Body Circumference	Anterior Depth of Belt	Height of Back Piece	Product Code
1	582-001-S	60 - 70cm	18cm	Extra Small (42cm)	761-070-S
2	582-002-S	70 - 80cm	18cm	Small (46cm)	761-071-S
3	582-003-S	80 - 90cm	18cm	Medium (50cm)	761-072-S
4	582-004-S	90 - 105cm	18cm	Large (56cm)	761-073-S
5	582-005-S	105 - 120cm	18cm		
6	582-006-S	120 - 135cm	18cm		

Brace Orthopaedic MKS® Osteo Flex Plus

- Semi-elastic bandaging material with lateral reinforcing stays
- Firm abdominal piece with hook and loop fastener
- Textile back piece with paravertebral steel tape rods
- Additional tensioning straps
- Adjustable back plate with incorporated aluminium profile
- Reclination straps
- Individual strap course



Body Belt Plus + Osteo Flex Back Plate = Osteo Flex Plus. To make a modular Osteo Flex TLSO solution please choose the appropriate belt and back plate options from the following charts.

MKS® Osteo Flex Plus

Size	Product Code	Body Circumference	Anterior Depth of Belt	Height of Back Piece	Product Code
1	582-201-S	60 - 70cm	18cm	Extra Small (42cm)	761-070-S
2	582-202-S	70 - 80cm	18cm	Small (46cm)	761-071-S
3	582-203-S	80 - 90cm	18cm	Medium (50cm)	761-072-S
4	582-204-S	90 - 105cm	18cm	Large (56cm)	761-073-S
5	582-205-S	105 - 120cm	18cm		
6	582-206-S	120 - 135cm	18cm		

Brace Orthopaedic MKS® Osteo

- Semi-elastic bandaging material with lateral reinforcing stays
- Adjustable back plate with incorporated aluminium profile
- Firm abdominal piece with hook and loop fastener
- Reclination straps
- Individual strap course

Body Belt + Osteo Back Plate = Osteo. To make a modular Osteo Flex TLSO solution please choose the appropriate belt and back plate options from the following charts.

MKS® Osteo Flex

Size	Product Code	Body Circumference	Anterior Depth of Belt	Height of Back Piece	Product Code
1	582-001-S	60 - 70cm	18cm	Extra Small (42cm)	761-065-S
2	582-002-S	70 - 80cm	18cm	Small (46cm)	761-066-S
3	582-003-S	80 - 90cm	18cm	Medium (50cm)	761-067-S
4	582-004-S	90 - 105cm	18cm	Large (56cm)	761-068-S
5	582-005-S	105 - 120cm	18cm		
6	582-006-S	120 - 135cm	18cm		



Brace Orthopaedic MKS® Osteo Plus

- Semi-elastic bandaging material with lateral reinforcing stays
- Adjustable back plate with incorporated aluminium profile
- Firm abdominal piece with hook and loop fastener
- Additional tensioning straps
- Reclination straps
- Individual strap course

Body Belt Plus + Osteo Back Plate = Osteo Plus. To make a modular Osteo Flex TLSO solution please choose the appropriate belt and back plate options from the following charts.

MKS® Osteo Flex Plus

Size	Product Code	Body Circumference	Anterior Depth of Belt	Height of Back Piece	Product Code
1	582-201-S	60 - 70cm	18cm	Extra Small (42cm)	761-065-S
2	582-202-S	70 - 80cm	18cm	Small (46cm)	761-066-S
3	582-203-S	80 - 90cm	18cm	Medium (50cm)	761-067-S
4	582-204-S	90 - 105cm	18cm	Large (56cm)	761-068-S
5	582-205-S	105 - 120cm	18cm		
6	582-206-S	120 - 135cm	18cm		



Brace Orthopaedic MKS® Thorecta

- Adjustable, stable aluminium profiles
- All section parts are padded
- Individual strap course
- Compression padding for the waist
- Adjustable, firm thoracic support
- Clip fasteners for easy handling

MKS® Thorecta

Size	Product Code	Body Circumference	Height of Front Piece	Height of Back Piece
XS	731X	70 - 125cm	35 - 40cm	33 - 38cm
S	731C	70 - 125cm	40 - 47cm	33 - 38cm
M	731A	70 - 125cm	48 - 53cm	33 - 38cm
L	731B	70 - 125cm	54 - 59cm	40 - 45cm



Brace Orthopaedic MKS® Thorecta Plus

- Adjustable, stable aluminium profiles
- All section parts are padded
- Individual strap course
- Compression padding for the waist
- Adjustable, firm thoracic support
- Reclination straps
- Clip fasteners for easy handling

MKS® Thorecta

Size	Product Code	Body Circumference	Height of Front Piece	Height of Back Piece
XS	751X	70 - 125cm	35 - 40cm	48 - 51cm
S	751C	70 - 125cm	40 - 47cm	52 - 56cm
M	751A	70 - 125cm	48 - 53cm	59 - 63cm
L	751B	70 - 125cm	54 - 59cm	66 - 70cm





Hernia

Promedics Neoprene Abdominal Binder

- Durable neoprene material
- Easy adjustment with hook/loop closure
- Abdominal, post-natal and post-surgical application
- Provides compression and support for strains and weakness of the abdominal area



Abdominal Binder

Product Code	Size
ABWN/10	Universal

Ossur Abdominal Binder

- Manufactured from high quality neoprene
- Posterior depth at back 254mm
- Simple anterior touch and close fastening with posterior elasticated cross-over for extra support
- Flexible posterior and anterior stays prevent uncomfortable edge roll-over



Abdominal Binder

Product Code	Size
0150	Universal

Ossur Temporary Hernia Support Available direct from Sheffield stock

- Manufactured from high quality neoprene
- Posterior depth at back 254mm
- Simple anterior touch and close fastening with posterior elasticated cross-over for extra support
- Flexible posterior and anterior stays prevent uncomfortable edge roll-over



Temporary Hernia Support

Product Code	Size	Height
1043	Universal	Approx. 22cm
1044	Universal	Approx. 30cm

Thuasne Ortel Hernia Belt - Unilateral

- Truss for reducible inguinal hernias
- Suitable for pre or post-op support
- Removable and repositionable silicone pads
- Unique buckle system allows left/right adjustment



Thuasne Ortel Hernia Belt - Unilateral

Size	Product Code	Waist Circumference
1	27300120100199	75 - 85cm
2	27300120200199	86 - 97cm
3	27300120300199	98 - 110cm
4	27300120400199	111 - 125cm

Thuasne Ortel Hernia Belt - Bilateral

- Truss for reducible inguinal hernias
- Suitable for pre or post-op support
- Removable and repositionable silicone pads



Thuasne Ortel Hernia Belt - Bilateral

Size	Product Code	Waist Circumference
1	27200120100199	75 - 85cm
2	27200120200199	86 - 97cm
3	27200120300199	98 - 110cm
4	27200120400199	111 - 125cm

Orthotix Flexoflex Hernia Belt

- Two adjustable straps under the thighs, which can be worn directly on skin
- 100% cotton and breathable fabric
- Includes a complimentary pair of hernia pads which can be worn for enhanced containment of reducible inguinal hernias

Orthotix Flexoflex Hernia Belt

Size	Product Code	Pelvic Circumference
Small (65)	623/S/65	71 - 77cm
Small (70)	623/S/70	77 - 82cm
Medium (75)	623/M/75	82 - 88cm
Medium (80)	623/M/80	88 - 94cm
Large (85)	623/L/85	94 - 100cm
Large (90)	623/L/90	100 - 105cm
X Large (95)	623/XL/95	105 - 110cm
X Large (100)	623/XL/100	110 - 117cm
XX Large (105)	623/2XL/105	117 - 123cm



Orthotix Gents Hernia Briefs Standard

- Standard waist brief (11" depth)
- Briefs offer strong tension, providing effective abdominal support
- Features internal slip pockets for optional pads if increased compression to the inguinal area is required
- 100% cotton for premium comfort
- Hypoallergenic and sanitized
- Includes a complimentary pair of hernia pads (left and right)



Orthotix Gents Hernia Briefs Standard

Size	Product Code	Pelvic Circumference
Small 65	651/S/65	71-77cm
Small 70	651/S/70	77-82cm
Medium 75	651/M/75	82-88cm
Medium 80	651/M/80	88-94cm
Large 85	651/L/85	94-100cm
Large 90	651/L/90	100-105cm
X Large 95	651/XL/95	105-110cm
X Large 100	651/XL/100	110-117cm
2X Large 105	651/2XL/105	117-123cm
2X Large 110	651/2XL/110	123-130cm

Please note colours may vary between white and cream.

Orthotix Gents Hernia Briefs High Waist

- High waist brief (13" depth)
- Briefs offer strong tension, providing effective abdominal support
- Features internal slip pockets for optional pads if increased compression to the inguinal area is required
- 100% cotton for premium comfort
- Hypoallergenic and sanitized
- Includes a complimentary pair of hernia pads (left and right)



Orthotix Gents Hernia Briefs High Waist

Size	Product Code	Pelvic Circumference
Small 65	652/S/65	71-77cm
Small 70	652/S/70	77-82cm
Medium 75	652/M/75	82-88cm
Medium 80	652/M/80	88-94cm
Large 85	652/L/85	94-100cm
Large 90	652/L/90	100-105cm
X Large 95	652/XL/95	105-110cm
X Large 100	652/XL/100	110-117cm
2X Large 105	652/2XL/105	117-123cm
2X Large 110	652/2XL/110	123-130cm

Please note colours may vary between white and cream.

Orthotix Gents Hernia Underwear

- Recommended for inguinal hernia treatment and containment
- Constructed from a medium tensile antibacterial Radyarn®
- Elastic cotton for optimised comfort, with integrated support panels for the groin
- Features internal slip pockets that can accommodate hernia pads for additional hernia containment and support
- Includes front opening
- Low profile design makes the garment ideal for everyday use and sporting activities



Orthotix Gents Hernia Underwear

Size	Product Code	Hip Circumference
S	656/S	71 – 82cm
M	656/M	82 – 94 cm
L	656/L	94 – 105cm
XL	656/XL	105 – 117cm
XXL	656/2XL	117 – 130 cm

Orthotix Hernia Boxer

- Comfortable and easy to wear with accessible opening on the front panel
- Offers premium comfort against the skin
- Hypoallergenic and sanitised
- Ideal for use during sports or everyday activities
- Includes a complimentary pair of hernia pads (left and right)
- Washable at 40°C



Orthotix Hernia Boxer - Black

Size	Product Code	Hip Circumference
S	655/S	71 – 82cm
M	655/M	82 – 94 cm
L	655/L	94 – 105cm
XL	655/XL	105 – 117cm
XXL	655/2XL	117 – 130 cm

Orthotix Ladies Hernia Briefs Standard Waist

- Standard waist pants (11" depth)
- Briefs offer strong tension, providing effective abdominal support
- Features internal slip pockets for optional pads if increased compression to the inguinal area is required
- Front opening crotch area fastened via a hook and eye closure
- 100% cotton for premium comfort
- Hypoallergenic and sanitized
- Includes a complimentary pair of hernia pads (left and right)

Orthotix Ladies Hernia Briefs Standard Waist

Size	Product Code	Pelvic Circumference
Small 65	672/S/65	71-77cm
Small 70	672/S/70	77-82cm
Medium 75	672/M/75	82-88cm
Medium 80	672/M/80	88-94cm
Large 85	672/L/85	94-100cm
Large 90	672/L/90	100-105cm
X Large 95	672/XL/95	105-110cm
X Large 100	672/XL/100	110-117cm
2X Large 105	672/2XL/105	117-123cm
2X Large 110	672/2XL/110	123-130cm



Orthotix Ladies Hernia Briefs High Waist

- High waist pants (13" depth)
- Briefs offer strong tension, providing effective abdominal support
- Front opening crotch area fastened via a hook and eye closure
- 100% cotton for premium comfort
- Hypoallergenic and sanitized

Orthotix Ladies Hernia Briefs High Waist

Size	Product Code	Pelvic Circumference
Small 65	671/S/65	71-77cm
Small 70	671/S/70	77-82cm
Medium 75	671/M/75	82-88cm
Medium 80	671/M/80	88-94cm
Large 85	671/L/85	94-100cm
Large 90	671/L/90	100-105cm
X Large 95	671/XL/95	105-110cm
X Large 100	671/XL/100	110-117cm
2X Large 105	671/2XL/105	117-123cm
2X Large 110	671/2XL/110	123-130cm





Maternity

Promedics Maternity Belt Style B

- Cut away design at the front gives comfort when sitting and prevents belt from rolling up
- Angled posterior seams give improved shaping around the sacrum
- Made in stronger lenoweave elastic/cotton mix for extra support
- Back depth 20cm, front depth 17cm
- Also available in black
- **Contains latex**



Maternity Belt Style B

Product Code (White)	Product Code (Black)	Circumference (at widest part of abdomen)
MBB/1	MBB/1/BK	90 - 96cm
MBB/2	MBB/2/BK	96 - 102cm
MBB/3	MBB/3/BK	102 - 108cm
MBB/4	MBB/4/BK	108 - 116cm
MBB/5	MBB/5/BK	116 - 126cm
MBB/6	MBB/6/BK	126 - 136cm
MBB/7	MBB/7/BK	136 - 146cm
MBB/8	MBB/8/BK	146 - 156cm
MBB/9	MBB/9/BK	156 - 165cm

Promedics Maternity Belt Style C

- Low-cut design makes it comfortable to wear when sitting
- Angled posterior seams give improved shaping around the sacrum
- Made in stronger lenoweave elastic/cotton mix for extra support
- Back depth 16cm, front depth 11cm
- Also available in black
- **Contains latex**



Maternity Belt Style C

Product Code (White)	Product Code (Black)	Circumference (at widest part of abdomen)
MBC/1	MBC/1/BK	90 - 96cm
MBC/2	MBC/2/BK	96 - 102cm
MBC/3	MBC/3/BK	102 - 108cm
MBC/4	MBC/4/BK	108 - 116cm
MBC/5	MBC/5/BK	116 - 126cm
MBC/6	MBC/6/BK	126 - 136cm
MBC/7	MBC/7/BK	136 - 146cm
MBC/8	MBC/8/BK	146 - 156cm
MBC/9	MBC/9/BK	156 - 165cm

Promedics Pelvic Instability Belt

- 'Many-tailed bandage' pattern allows variable tension on each set of straps
- Adaptable to a standing or sitting position
- Can be worn over clothing
- Provides strong circumferential support around the pelvis, holding the two sacroiliac joints and the symphysis pubis joint firmly
- Also available in black
- **Contains latex**



Pelvic Instability Belt

Product Code (White)	Product Code (Black)	Circumference (at widest part of abdomen)
SPD/1	SPD/1/BK	90 - 96cm
SPD/2	SPD/2/BK	96 - 102cm
SPD/3	SPD/3/BK	102 - 108cm
SPD/4	SPD/4/BK	108 - 116cm
SPD/5	SPD/5/BK	116 - 126cm
SPD/6	SPD/6/BK	126 - 136cm
SPD/7	SPD/7/BK	136 - 146cm
SPD/8	SPD/8/BK	146 - 156cm

Promedics Wiltshire Maternity Belt

- Pelvic support belt with an elastic back section and two padded side straps, plus two variable tension straps
- Slimline design makes it comfortable to wear when sitting
- Provides strong circumferential support around the pelvis, holding the two sacroiliac joints and the symphysis pubis joint firmly
- Back depth 10cm, front depth 8cm.
- Also available in black
- **Contains latex**



Wiltshire Maternity Belt

Product Code (White)	Product Code (Black)	Circumference
WMB/1	WMB/1/BK	96 - 116cm
WMB/2	WMB/2/BK	116 - 130cm
WMB/3	WMB/3/BK	130 - 146cm
WMB/4	WMB/4/BK	146 - 160cm



Cervical

Aspen Vista II CTLSO

- Features an innovative symmetrical back panel that integrates with the VRTX CTLSO for a cervical to sacrum solution
- Specialised anterior tightening adjustments allow for more efficient clinician application
- Easy multistep cervical and sternal adjustability
- Optimal motion restriction
- Comfort without compromising care
- Supports progression of care
- Aspen's flagship padding
- Flexible thoracic adjustment
- Locking sternal adjustment
- Modular treatment
- Two piece design

Aspen Vista II CTLSO

Product Code	Size	Measurements
984690	Extra Small	66 - 91.5cm
984680	Standard	78.7 - 152.4cm
984700	Extra Large	129.5 - 177.8cm



This comprehensive off the-shelf cervical to sacrum solution enhances the overall efficiency of hospital operations.

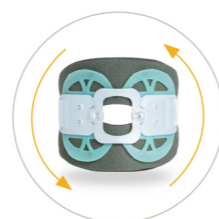

Symmetrical Back Panel

The Vista II collar features an innovative symmetrical back panel that streamlines fitting and reduces the risk of incorrect patient application. The symmetrical posterior panel serves as a visual cue, ensuring that the collar is applied accurately and securely.

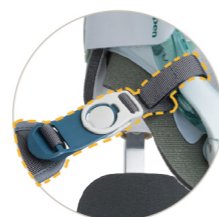

Connecting Straps

Adjustable straps easily connect the Vista II collar with the Vista II CTLSO upgrade kit for multilevel spinal support.



Cervical and Sternal Adjustability

Easy multi step cervical and sternal adjustability allows clinician to provide the care and comfort needed for the patient.

Anterior Panel Height

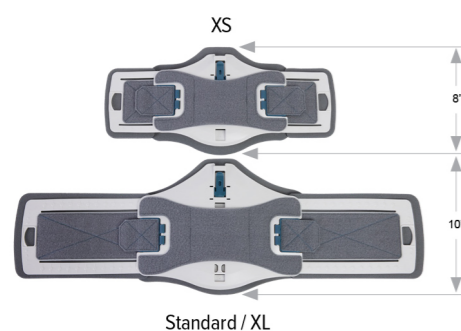

Posterior Panel Height

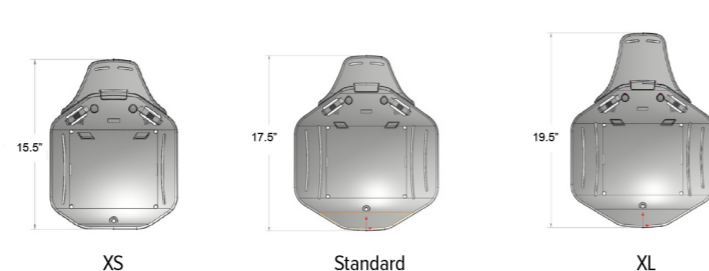

Promedics Aspen Vista® Collar Available direct from Sheffield stock

- Incorporates six sizes in one collar
- Extra large patient access window
- Dial height adjustment selects one of six height settings
- Cotton-lined pads wick moisture from skin



Vista® Collar

Product Code	Description
984002	Vista® Collar Set
984000	Vista® Collar
984020	Vista® Collar Replacement Pad Set

Promedics Aspen Vista® Collar TX Available direct from Sheffield stock

- Encompasses all of the features and benefits of the popular Vista Collar with the addition of a detachable thoracic extension for added coverage in the thoracic region
- Incorporates six sizes in one collar
- Extra large patient access window
- Dial height adjustment selects one of six height settings
- Cotton-lined pads wick moisture from skin



Vista® Collar TX

Product Code	Description
984102	Vista® Collar TX Set
984100	Vista® Collar TX
984120	Vista® Collar TX Replacement Pad Set

Promedics Aspen Vista II Cervical Collar

- Integrates original Vista Cervical Collar with a new reversible back panel to ensure precise and consistent application
- One size adjustable
- Dial height with six height settings
- Extra large access window
- Reduce inventory and waste
- Improved skin care
- Symmetrical back panel
- Reduced incorrect patient application



Promedics Vista II Collar

Product Code	Description
984300	Vista II Collar
984302	Vista II Collar Set
984320	Vista II Collar Replacement Pads

Promedics Aspen CTO4

- Designed to provide increased motion restriction in all three planes of motion—flexion/extension, lateral bending, and axial rotation
- Comfortable and padded at all contact points to help ensure compliance
- Can easily be stepped down to the Vista CTO and then the Vista MultiPost Collar to support the progression of care
- Maximum motion restriction
- Universal size

Promedics Aspen CTO4

Product Code Description

984550	Promedics Aspen CTO4
984520	Promedics Aspen CTO4 Replacement Pad Set
984554	Promedics Aspen CTO4 Upgrade Kit - Posterior



Promedics Aspen Vista® Multipost Collar

- Pivoting occipital panels
- Designed to reduce pressure
- Superior motion restriction
- Fully adjustable front and back panels
- Promotes effective skin care
- Increased visibility for improved care
- One-size-adjustable

Promedics Aspen Vista® Multipost Collar

Product Code Description

984200	Aspen Vista® Multipost Collar
984202	Aspen Vista® Multipost Collar - Set
984220	Aspen Vista® Multipost Collar Replacement Pads



Promedics Aspen CTO

- Cervical and upper thoracic spinal brace
- Combines highly effective immobilisation of the cervical and upper thoracic spine
- Offers 'step-down' alteration for ongoing rehabilitation therapy
- Improves comfort and patient compliance
- Unlimited adjustability
- MRI compatible
- Replacement liners available
- Paediatric sizes available

Aspen CTO

Product Code	Size	Measurements (chin to shoulder depth)
983308	Short	57mm
983310	Regular	76mm
983312	Tall	96mm
983314	Extra Tall	114mm
983320	Replacement Pad Set	Universal



Promedics Aspen Vista® Multipost Therapy Collar

- Designed to reduce symptoms associated with cervical conditions such as cervicogenic headaches, Forward Head Carriage and "Text Neck"
- Fully adjustable front and back panels
- Pneumatic compression bladder
- Integrated air pump
- Hot/cold therapy

Promedics Aspen Vista® Multipost Therapy Collar

Product Code Description

984250	Aspen Vista® Multipost Therapy Collar
984252	Aspen Vista® Multipost Therapy Collar Replacement Pads



Promedics Aspen Collar

- Designed to optimise support and comfort
- Engineered to provide substantial motion restriction without producing painful pressure points that can lead to skin breakdown
- All contact surfaces are cushioned with cotton-lined, breathable foam padding for ultimate comfort
- Unique Cushion Flex Tabs™ enable a customised fit
- Occipital Support Strap™ creates an adjustable, three-dimensional 'shelf' that cradles the back of the head

Aspen Collar

Product Code	Size	Measurements (chin to shoulder depth)
983108	Short	57mm
983110	Regular	76mm
983112	Tall	96mm
983114	Extra Tall	114mm
983159	Replacement Pad Set	Universal



Promedics Aspen® Sierra Universal Collar™

- Fits the vast majority of patients without adjustment
- Helps reduce inventory requirements
- Unique design provides comfort, motion restriction and protection
- Designed from closed cell foam - excellent for use as a shower collar

Promedics Aspen® Sierra Universal Collar™

Product Code	983125
--------------	--------



Promedics Budget Collar

- Made in fully washable, medium density closed cell foam
- Will not collapse with use
- Stabilises the neck after trauma, or for long term use as a night resting collar

Promedics Budget Collar

Size	Product Code	Depth x Length
Small	BC/1	7.5 x 43cm
Medium	BC/2	9 x 47cm
Large	BC/3	9 x 51cm
Large/Deep	BC/4	10 x 51cm



Promedics Philly Collar

- Lightweight, two-piece collar in Plastazote, with rigid occipital and mandibular posts
- Strong comfortable support for the head and neck
- Incorporates a tracheal access hole
- Philly Collar Stabiliser (PCS/10 - one size), is available on request; its anterior and posterior attachments further restrict cervical movement

Promedics Philly Collar

Product Code	Neck Circumference	Collar Depth
PCC/33	25.5 x 30.5cm	8.5cm
PCC/53	33 x 38cm	8.5cm
PCC/73	41 x 48cm	8.5cm
PCC/34	25.5 x 30.5cm	11cm
PCC/54	33 x 38cm	11cm
PCC/74	41 x 48cm	11cm

(5.5cm & 13.5cm depths available on request)



Ossur Miami J® Cervical Collar

- Superior c-spine immobiliser
- Patented design
- Features Sorbatex™ II padding, which is antibacterial and clinically proven to inhibit microbial growth, enhancing comfort and patient compliance
- Bioengineered to minimize pressure points in the key areas of the chin, occiput, trapezius and clavicle
- Sizing based on 7 phenotypes to ensure proper fit and optimum immobilisation
- Comfort adjustment buttons for occiput and mandible, removable sternal pad for supine and swallowing
- Replacement pads available



Miami J® Cervical Collar - Collar Sets and Accessories

Size	Product Code Collar	Product Code Collar Set	Replacement Pads
Super Short*	MJ-200S	MJR-200S	MJP-100
Stout	MJ-200L	MJR-200L	MJP-200L
XS	MJ-250	MJR-250	MJP-250
Tall	MJ-500	MJR-500	MJP-100
Regular	MJ-400	MJR-400	MJP-100
Short	MJ-300	MJR-300	MJP-100

* Super Short collars are packaged with Medium Back Panels.

Miami J® Cervical Collar - Front and Back Panels

Size	Product Code Front	Product Code Back
Super Short*	MJ-200SFRT	MJ-400BK
Stout	MJ-200LFRT	MJ-200LBK
XS	MJ-250FRT	MJ-250BK
Tall	MJ-500FRT	MJ-500BK
Regular	MJ-400FRT	MJ-400BK
Short	MJ-300FRT	MJ-300BK

Miami J® Front and Back Panels may be interchanged to accommodate patient anatomy, e.g., a Small Front may be used with a Large Back.

Ossur Miami JTO® Extension

- Provides more control than a collar alone can provide
- Innovative device designed to treat cervical and high thoracic injuries
- Patented design with floating back permits maximum immobilisation without the risk of compensatory motion
- Snap on and off without any tools
- Features Sorbatex™ II padding, which is antibacterial and clinically proven to inhibit microbial growth, enhancing comfort and patient compliance
- Replacement pads available

Miami JTO® Extension

Size	Product Code	Replacement Pads	Product with Replacement Pads
Universal	MT-900	MTP-950	MTR-900



Ossur Miami J® Select Collar

- Easy height adjustability with a tamper-proof locking mechanism – ‘Left to Lock’
- Anti-microbial and biocompatible Sorbatex™ padding prevents bacterial build-up
- 7 precise fitting sizes with opportunity to fine-tune
- Miami J® inspired chin tray
- One-piece, anatomically inspired collar back with Flex Edge® designed to reduce occipital pressure
- Easy to don and doff universal design with patented Reproducible Fit option
- Intuitive blue Patient Touch-Points to send patients home with confidence – Blue is You™
- Simplified comfort adjustments with integrated and patented Sternal-Relief Dial
- Large tracheal opening – improved function for ICU patients
- Easy to clean and replace multi-coloured padding
- X-ray and CT lucent, MR-safe
- Compatible with Occian™ Back & Miami JTO® accessories



Ossur Miami J® Select Collar

Size	Product Code
Universal	MJS-101

Ossur Miami J® Select Collar Set

Size	Product Code
Universal	MJSR-101

NeuroFlex® Restorative Kentucky Kollar

- Treats conditions such as torticollis (wry neck)
- Adjustable strap at neck seats and secures the collar on the shoulder
- Pad under the arm provides comfort and redistributes skin pressure
- High-temperature, remouldable plastic
- Flex Technology applies flexible low-load passive stretch (LLPS) to encourage the muscle to relax and improve the head posture
- Optional forehead strap available for all sizes



NeuroFlex® Restorative Kentucky Kollar

Size	Product Code	Forehead to Shoulder Measurement
Extra Extra Extra Small	RM0254	5 - 7.5cm
Extra Extra Small	RM0252	6 - 9cm
Extra Small	RM0250	9 - 11.5cm
Small	RM0248	10 - 12.5cm
Medium	RM0246	12.5 - 15cm
Large	RM0244	15 - 17.5cm
Extra Large	RM0242	17.5 - 22.5cm

Trulife Hensinger Head Support

- Foam wrap-around collar supports the head
- Used in conjunction with a harness
- Maintains mid-line head position
- Made from waterproof foam coated in a flexible plastic
- Soft covers included



Trulife Hensinger Head Support - Accessories

Description	Size	Product Code
Cover 7901 - Pair	Small	60817000011
Cover 7901 - Pair	Medium	60817000012
Cover 7901 - Pair	Large	60817000013
Replacement Strap	Extra Small	60818000010
Replacement Strap	Small	60818000011
Replacement Strap	Medium	60818000012
Replacement Strap	Large	60818000013
Reducer 6821	Narrow	60818000014
Reducer 6821	Wide	60818000015

Trulife Hensinger Head Support - Unmounted Model

Size	Product Code	Neck Circ.
Extra Small	60816000010	25cm
Small	60816000011	30cm
Medium	60816000012	38cm
Large	60816000013	43cm

KSA Headmaster Collar

- Provides excellent support and control
- Open design is cool and unobtrusive to wear
- Bend manually for custom fit
- Soft rear strap with hook-and-loop closure
- Optional Extension Neck Pad attach to inside rear of neck strap for extension support
- Neck pad and Neck Extension Pads are fully cloth-covered
- Measure from center of chin to corner of jaw. If measurements fall between sizes, choose smaller size



KSA Headmaster Collar Latex Free

Size	Product Code - KSA
Small	2970002672/523685S
Medium	2970002673/52368M
Large	2970002668/52368L

KSA Headmaster Collar - Neck Pads

Size	Product Code
Small/Junior	2970002587/52170S/J
Medium/Large	2970002586/52170M/L



Thuasne Ortel C1 Anatomic Collar

- Anatomically-shaped support foam
- Comfortable, removable and washable cover
- Easy application and precise self-fastening adjustment
- Available in 4 heights: 6cm, 7.5cm, 9cm and 11cm
- Available in Navy Blue and Beige



Thuasne Ortel C1 Anatomic Collar

Size	Product Code - Beige 6cm	Product Code - Beige 7.5cm	Product Code - Beige 9cm	Product Code - Beige 11cm	Product Code - Navy Blue 6cm	Product Code - Navy Blue 7.5cm	Product Code - Navy Blue 9cm	Product Code - Navy Blue 11cm	Neck Circ.
0	23940320000602	N/A	23940320000902	23940320001102	23940320000604	N/A	23940320000904	23940320001104	24 - 29cm
1	23940320100602	23940320100702	23940320100902	23940320101102	23940320100604	23940320100704	23940320100904	23940320101104	28 - 33cm
2	23940320200602	23940320200702	23940320200902	23940320201102	23940320200604	23940320200704	23940320200904	23940320201104	34 - 39cm
3	N/A	23940320300702	23940320300902	23940320301102	N/A	23940320300704	23940320300904	23940320301104	40 - 46cm

Thuasne Ortel C1 Classic Collar

- High-quality foam provides flexible support
- Comfortable, removable and washable cover
- Precise self-fastening adjustment
- Available in 4 heights: 6cm, 7.5cm, 9cm and 11cm



Thuasne Ortel C1 Classic Collar

Size	Product Code - 6cm	Product Code - 7.5cm	Product Code - 9cm	Product Code - 11cm	Neck Circ.
0	23930320000602	N/A	23930320000902	23930320001102	24 - 29cm
1	23930320100602	23930320100702	23930320100902	23930320101102	28 - 33cm
2	23930320200602	23930320200702	23930320200902	23930320201102	34 - 39cm
3	N/A	23930320300702	23930320300902	23930320301102	40 - 46cm

Thuasne Ortel C2+ Collar

- Semi-rigid internal structure covered in compact support foam
- Comfortable, removable and washable cover
- Precise self-fastening adjustment
- Available in 4 heights: 6cm, 7.5cm, 9cm and 11cm
- Available in Navy Blue and Beige



Thuasne Ortel C2+ Collar

Size	Product Code - Beige 6cm	Product Code - Beige 7.5cm	Product Code - Beige 9cm	Product Code - Beige 11cm	Product Code - Navy Blue 6cm	Product Code - Navy Blue 7.5cm	Product Code - Navy Blue 9cm	Product Code - Navy Blue 11cm	Neck Circ.
0	23920520000602	N/A	23920520000902	23920520001102	23920520000604	N/A	23920520000904	23920520001104	24 - 29cm
1	23920520100602	23920520100702	23920520100902	23920520101102	23920520100604	23920520100704	23920520100904	23920520101104	28 - 33cm
2	23920520200602	23920520200702	23920520200902	23920520201102	23920520200604	23920520200704	23920520200904	23940320201104	34 - 39cm
3	N/A	23920520300702	23920520300902	23920520301102	N/A	23920520300704	23920520300904	23940320301104	40 - 46cm

Thuasne Ortel C3 Collar

- Stabilisation: Anatomically-shaped chin support aids stabilisation
- Precise self-fastening height and easy adjustment (9 cm to 13 cm)
- Easy application



Thuasne Ortel C3 Collar

Size	Product Code - 10cm	Neck Circumference
1	23910320101003	28 - 33cm
2	23910320201003	34 - 39cm
3	23910320301003	40 - 46cm



Head Protection

Helmets are not available for return/credit due to infection control.

ATO Form Starlight® Standard Helmet Available direct from Sheffield stock

- Lightweight head protection
- Cotton jersey lining ensures good moisture circulation with a robust cover
- Adjustable chin strap as standard
- Available in 2 styles, in red and blue
- Fits head circumference from 42-62cm
- Washable at 40 degrees
- Accessories available (chargeable, see below): chin protection/fix lock fastener/hook and loop fastener



Starlight Standard



Starlight Standard Closed Top

Starlight® Standard Helmet

Product Code - Red	Product Code - Blue	Head Circumference
5180-1-42	5180-2-42	42cm
5180-1-43	5180-2-43	43cm
5180-1-44	5180-2-44	44cm
5180-1-45	5180-2-45	45cm
5180-1-46	5180-2-46	46cm
5180-1-47	5180-2-47	47cm
5180-1-48	5180-2-48	48cm
5180-1-49	5180-2-49	49cm
5180-1-50	5180-2-50	50cm
5180-1-51	5180-2-51	51cm
5180-1-52	5180-2-52	52cm
5180-1-53	5180-2-53	53cm
5180-1-54	5180-2-54	54cm
5180-1-55	5180-2-55	55cm
5180-1-56	5180-2-56	56cm
5180-1-57	5180-2-57	57cm
5180-1-58	5180-2-58	58cm
5180-1-59	5180-2-59	59cm
5180-1-60	5180-2-60	60cm
5180-1-61	5180-2-61	61cm
5180-1-62	5180-2-62	62cm

Starlight® Standard Closed Top Helmet

Product Code - Red	Product Code - Blue	Head Circumference
5280-1-42	5280-2-42	42cm
5280-1-43	5280-2-43	43cm
5280-1-44	5280-2-44	44cm
5280-1-45	5280-2-45	45cm
5280-1-46	5280-2-46	46cm
5280-1-47	5280-2-47	47cm
5280-1-48	5280-2-48	48cm
5280-1-49	5280-2-49	49cm
5280-1-50	5280-2-50	50cm
5280-1-51	5280-2-51	51cm
5280-1-52	5280-2-52	52cm
5280-1-53	5280-2-53	53cm
5280-1-54	5280-2-54	54cm
5280-1-55	5280-2-55	55cm
5280-1-56	5280-2-56	56cm
5280-1-57	5280-2-57	57cm
5280-1-58	5280-2-58	58cm
5280-1-59	5280-2-59	59cm
5280-1-60	5280-2-60	60cm
5280-1-61	5280-2-61	61cm
5280-1-62	5280-2-62	62cm

ATO Form Starlight® Base Helmet

- High quality, hardwearing cotton
- Lateral protection with air circulation
- Optional forehead and/or neck cushions
- Shock absorbing foam cross cushion attached with hook and loop fastening
- Adjustable chin strap and fasteners, hook and loop reverse pull standard fastening as standard
- Accessories available (chargeable, see below left): chin protection/neck protection/forehead protection/fix lock fastener



Starlight® Base Helmet

Size	Product Code - Grey	Product Code - Blue	Head Circumference
1	C402001-1	C402001-2	47 - 49cm
2	C402002-1	C402002-2	50 - 52cm
3	C402003-1	C402003-2	53 - 55cm
4	C402004-1	C402004-2	56 - 59cm
5	C402005-1	C402005-2	60 - 62cm

Additional Head and Neck Protection

Product Code	Description
C4013B	Secure-Base Forehead Protection
C4014B	Secure-Base Neck Protection

ATO Form Starlight® Secure Helmet

- High quality foam and hardwearing cotton
- Features individually adjustable shock absorbing foam trapeze cushions
- Optional forehead and/or neck cushions, fitted with hook and loop fastening
- Adjustable chin straps - standard fastening, hook and loop reverse pull standard fastening
- Accessories available (chargeable, see left): chin protection/neck protection/forehead protection/fix lock fastener



Starlight® Secure Helmet

Size	Product Code - Grey	Product Code - Blue	Head Circumference
1	C401101B-1	C401101B-2	47 - 49cm
2	C401102B-1	C401102B-2	50 - 52cm
3	C401103B-1	C401103B-2	53 - 55cm
4	C401104B-1	C401104B-2	56 - 59cm
5	C401105B-1	C401105B-2	60 - 62cm

ATO Form Starlight® Helmet Accessories

- Various accessories are available to enhance the Starlight® Helmet range (all chargeable)



Description	Product Code	Size
Aqua Chin Protection	C4012-AQ	Standard/ Extra Large
Std/Base/Secure Chin Protection	C4012B	Standard/ Extra Large



Description	Product Code	Size
Hook and Loop Reverse Pull Fastening to Starlight	5182-02	Standard

Fixlock Fastening



Fixlock Fastening with Safety Lock



Description	Product Code
Fixlock Fastening	5182-02
Fixlock Fastening with Safety Lock	5182-02-SV

ATO Form Starlight® Aqua Helmet

- Can be worn during bathing, showering and water based leisure activities
- Neoprene construction with and a soft, shock absorbent integral foam
- Quick-drying, waterproof, easy to clean and resilience to fungi and bacteria
- Hand wash up to 30°
- Available in black
- Adjustable chin straps - standard fastening, hook and loop reverse pull standard fastening
- Accessories available (chargeable, see left): chin protection/hook and loop fastening/fix lock fastener, hook and loop reverse pull standard fastening



Starlight® Aqua Helmet

Size	Product Code	Head Circumference
1	C401101-AQ	48 - 49cm
2	C401102-AQ	50 - 52cm
3	C401103-AQ	53 - 55cm
4	C401104-AQ	56 - 59cm
5	C401105-AQ	60 - 62cm

Orliman Head Protex Helmet - Adult and Paediatric

- Comfortable superior lightweight breathable padded soft shell helmet
- Suitable for adults and children
- Aqua available in sizes 40cm to 60cm
- Pink and Black available in sizes 46cm to 60cm
- Front and rear bumper adaptions, and bespoke strap adaptions available
- Sizing fit snug so it is recommended to select the size above



Orliman Head Protex Helmet

Size	Product Code - Aqua	Product Code - Pink	Product Code - Black
40cm	HP/A/40	-	-
42cm	HP/A/42	-	-
44cm	HP/A/44	-	-
46cm	HP/A/46	HP/P/46	HP/B/46
48cm	HP/A/48	HP/P/48	HP/B/48
50cm	HP/A/50	HP/P/50	HP/B/50
52cm	HP/A/52	HP/P/52	HP/B/52
54cm	HP/A/54	HP/P/54	HP/B/54
56cm	HP/A/56	HP/P/56	HP/B/56
58cm	HP/A/58	HP/P/58	HP/B/58
60cm	HP/A/60	HP/P/60	HP/B/60

Orliman Head Protex Helmet Adaptions

Description	Product Code
Head Protex Front Bumper Adaption	HP/FB
Head Protex Rear Bumper Adaption	HP/RB
Bespoke Adaption to Straps only	HP/STRAP-ADAPT
This for additional strap length or changing fastening to hook/loop. Please state on your order your requirement when selecting this code.	

Beagle A-Flex Plus Protective Headgear (Orthomerica)

- Fabricated from a flexible plastic which conforms to varying head shapes making it easy-to-fit
- Forces distributed across the entire surface without cracking or penetrating the helmet
- Ventilation holes reduce trapped heat
- Easily trimmed without the need for complex equipment



Beagle A-Flex Plus Protective Headgear (Orthomerica) - Adult

Size	Product Code - Blue	Product Code - White	Head Circumference
X-Small	783.05	783.65	52 - 55cm
Small	783.06	783.66	54 - 57cm
Medium	783.07	783.67	57 - 60cm
Large	783.08	783.68	60 - 63cm
X-Large	783.09	783.69	63 - 66cm
XX-Large	783.1	783.7	66 - 69cm

Beagle A-Flex Plus Protective Headgear (Orthomerica) - Paediatric

Size	Product Code - White	Head Circumference
Small	783.61	40 - 43cm
Medium	783.62	43 - 46cm
Large	783.63	46 - 48cm
X-Large	783.64	48 - 51cm

Gel Innovations Viking Baseball Cap Kids Helmet

- Fashionable protective headgear incorporating a modern baseball cap style specifically designed for children
- Available in navy colour
- Features a removable back-of-head component and detachable adjustable Y-shape chin straps for improved safety
- Soft shell construction embedded with a unique absorbing foam that has been BSI tested to reduce force of impact. Its foam density shock absorbency rate is recorded at over 150Kgm³, which offers 360-degree protection without being bulky or stigmatising



Gel Innovations Viking Baseball Cap Kids Helmet

Size	Product Code - Navy
Midi/Maxi (Ø 50-55cm)	BB/N/Kids

Gel Innovations Ribcap Cotton Baseball Cap Adults Helmet

- Baseball cap style helmet
- Suitable for epilepsy and autism
- Supplied with chin strap
- Coolmax system ensures optimal temperature
- Lightweight and comfortable to wear
- 100% breathable
- Washable, foldable and storable



Gel Innovations Ribcap Cotton Baseball Cap Helmet

Size	Product Code - Navy	Product Code - Grey	Product Code - Red
S/M (Ø 53-58cm)	BB/N/S-M	BB/P/S-M	BB/R/S-M
L/XL (Ø 59-65cm)	BB/N/L-XL	BB/P/L-XL	BB/R/L-XL

Small and medium also fit children, Ribcap advise small 5-8 years old and medium 9-12 years old.

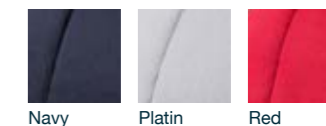

Gel Innovations Ribcap Beiber Kids Helmet

- Soft protective helmet
- Suitable for epilepsy, autism and general seizures
- Finest Merino wool outer
- Fleece lined inner
- Thick, protective foam is breathable and shock absorbent
- Light and comfortable to wear
- 100% breathable
- Washable, foldable and storable



Gel Innovations Ribcap Beiber Kids Helmet

Size	Product Code - Brown
Mini (Ø 47-49cm)	BIEBER/B/MINI
Midi (Ø 50-52cm)	BIEBER/B/MIDI
Maxi (Ø 53-55cm)	BIEBER/B/MAXI

Gel Innovations Ribcap Lenny Kids and Adult Helmet

- Kids beanie style protective helmet
- Finest Merino wool outer
- Coolmax system transfers perspiration away from the body
- Light and comfortable to wear
- 100% breathable
- Washable, foldable and storable



Gel Innovations Ribcap Lenny Kids Helmet

Size	Product Code - Anthracite	Product Code - Grey
Mini (Ø 47-49cm)	LENNY/A/MINI	LENNY/G/MINI
Midi (Ø 50-52cm)	LENNY/A/MIDI	LENNY/G/MIDI
Maxi (Ø 53-55cm)	LENNY/A/MAXI	LENNY/G/MAXI

Gel Innovations Ribcap Lenny Adults Helmet

Size	Product Code - Anthracite	Product Code - Grey	Product Code - Khaki	Product Code - Marine	Product Code - Rose
Small (Ø 53-55cm)	LENNY/A/S	LENNY/G/S	LENNY/K/S	LENNY/M/S	LENNY/R/S
Medium (Ø 56-58cm)	LENNY/A/M	LENNY/G/M	LENNY/K/M	LENNY/M/M	LENNY/R/M
Large (Ø 59-61cm)	LENNY/A/L	LENNY/G/L	LENNY/K/L	LENNY/M/L	LENNY/R/L
Extra Large (Ø 62-65cm)	LENNY/A/XL	LENNY/G/XL	-	-	-



Contracture Devices

Brace Orthopaedic CDS® Knee Brace Extension (90° Hinge)

- Allows individual adjustment of spring tension
- Spring tension can be switched on and off without tools and without varying the set spring tension
- Infinitely variable adjustment of the correction range in extension between -15° and +30°
- Individual adjustment of shells in position and shape
- High wearing comfort due to air-permeable, light-weight aluminium shells

CDS® Knee Brace Extension (90° Hinge)

Size	Product Code Left	Product Code Right	Length of Thigh Shell Medial	Length of Lower Leg Shell	Circumference of Thigh	Circumference of Lower Leg
Adolescent	901LM-L	901LM-R	23 - 25.5cm	26.5 - 29cm	33 - 43cm	24 - 35cm
Adult Small	901ML-L	901ML-R	18.5 - 21cm	20.5 - 23.5cm	36 - 66cm	32 - 47cm
Adult	901LL-L	901LL-R	23 - 25.5cm	26.5 - 29cm	36 - 66cm	32 - 47cm



Brace Orthopaedic CDS® Knee Brace Flexion (360° Hinge)

- Allows individual adjustment of spring tension
- Spring tension can be switched on and off without tools and without varying the set spring tension
- Infinitely variable adjustment of the correction range in flexion
- Individual adjustment of shells in position and shape
- High wearing comfort due to air-permeable, light-weight aluminium shells

CDS® Knee Brace Extension (90° Hinge)

Size	Product Code Left	Product Code Right	Length of Thigh Shell Medial	Length of Lower Leg Shell	Circumference of Thigh	Circumference of Lower Leg
Adolescent	904LM-L	904LM-R	23 - 25.5cm	26.5 - 29cm	33 - 43cm	24 - 35cm
Adult Small	904ML-L	904ML-R	18.5 - 21cm	20.5 - 23.5cm	36 - 66cm	32 - 47cm
Adult	904LL-L	904LL-R	23 - 25.5cm	26.5 - 29cm	36 - 66cm	32 - 47cm



Brace Orthopaedic CDS® Ankle Brace (360° Hinge)

- Allows individual adjustment of spring tension
- Spring tension can be switched on and off without tools and without varying the set spring tension
- Infinitely variable adjustment of the correction range in dorsiflexion
- Individual adjustment of shells in position and shape
- High wearing comfort due to air-permeable, light-weight aluminium shells



CDS® Ankle Brace (360° Hinge)

Size	Product Code Left	Product Code Right	Length of Lower Leg Shell	Shoe Size (UK)	Sole Length
Junior	920SXS-L	920SXS-R	23 - 31cm	Child 5.5 - Adult 2	23cm
Small	920LS-L	920LS-R	36 - 38.5cm	up to 6	26cm
Medium	920LM-L	920LM-R	36 - 38.5cm	6.5 - 9	27.5cm
Large	920LL-L	920LL-R	36 - 38.5cm	9.5 up	30cm

Brace Orthopaedic CDS® Paediatric Knee Brace Extension (90° Hinge)

- Allows individual adjustment of spring tension
- Spring tension can be switched on and off without tools and without varying the set spring tension
- Infinitely variable adjustment of the correction range in extension between -15° and +30°
- Individual adjustment of shells in position and shape
- High wearing comfort due to air-permeable, light-weight aluminium shells

CDS® Paediatric Knee Brace Extension (90° Hinge)

Size	Product Code Left	Product Code Right	Length of Thigh Shell Medial	Length of Lower Leg Shell	Circumference of Thigh	Circumference of Lower Leg
Malinki*	901XXS-L	901XXS-R	14 - 16.5cm	15 - 18.5cm	18 - 22cm	17 - 20cm
Bambini*	901XSXS-L	901XSXS-R	16.5 - 18.5cm	18.5 - 21.5cm	22 - 32cm	20 - 25cm
Junior	901SS-L	901SS-R	17.5 - 20cm	21.5 - 25cm	30 - 40cm	22 - 32cm

*Bambini and Malinki options have the 360° Nano Hinge.



Brace Orthopaedic CDS® Paediatric Knee Brace Flexion (360° Hinge)

- Allows individual adjustment of spring tension
- Spring tension can be switched on and off without tools and without varying the set spring tension
- Infinitely variable adjustment of the correction range in flexion
- Individual adjustment of shells in position and shape
- High wearing comfort due to air-permeable, light-weight aluminium shells

CDS® Paediatric Knee Brace Extension (90° Hinge)

Size	Product Code Left	Product Code Right	Length of Thigh Shell Medial	Length of Lower Leg Shell	Circumference of Thigh	Circumference of Lower Leg
Malinki*	904XXS-L	904XXS-R	14 - 16.5cm	15 - 18.5cm	18 - 22cm	17 - 20cm
Bambini*	904XSXS-L	904XSXS-R	16.5 - 18.5cm	18.5 - 21.5cm	22 - 32cm	20 - 25cm
Junior	904SS-L	904SS-R	17.5 - 20cm	21.5 - 25cm	30 - 40cm	22 - 32cm

*Bambini and Malinki options have the 360° Nano Hinge.



Brace Orthopaedic Paediatric CDS® Ankle Brace (360° Hinge)

- Precise height adjustment of hinge position for exact alignment with the anatomical joint axis
- Sole plate with double rocker allows limited indoor mobility
- Adjustable foot rotation between -5° and +5°
- Improved positioning of instep and heel strap
- Individual adjustment of the spring tension, which can be switched on and off without tools and without varying the set spring tension
- Variable adjustment of the correction range in dorsiflexion
- Individual adjustment of shells in position and shape
- High wearing comfort due to air-permeable, light-weight fabric shells

Brace Orthopaedic Paediatric CDS® Ankle Brace (360° Hinge)

Size	Product Code Left	Product Code Right	Length of Lower Leg Shell	Shoe Size (UK)	Sole Length
Malinki	920XXS-L	920XXS-R	15cm	Child 3.5 - 7.5	14.5cm
Bambini	920XSXS-L	920XSXS-R	18cm	Child 8 - 10.5	20cm
Junior	920SS-L	920SS-R	20cm	Child 11 - Adult 2	23cm



NeuroFlex® Restorative Knee Orthosis

- Padding provides comfort and reduces skin pressure
- High-temperature, remouldable plastic cuffs
- Adjustable dials allow gradual changes to move the joint towards normal alignment
- The brace provides 3-point leverage similar to manual stretching, improving range of motion
- Flex Technology splint moves with the patient's abnormal muscle tone/spasticity



NeuroFlex® Restorative Knee Orthosis

Size	Product Code	TTK	KTC	Circumference of Thigh	Circumference of Calf
Child	RM0002	12.5cm	15cm	20 - 30cm	17.5 - 25.5cm
Extra Small	RM0004	15cm	15cm	20 - 33cm	19 - 28cm
Small	RM0006	16.5cm	16.5cm	25.5 - 38cm	20 - 30cm
Medium	RM0008	19cm	19cm	33 - 43cm	25.5 - 38cm
Large	RM0010	21.5cm	21.5cm	40.5 - 56cm	35.5 - 45.5cm

NeuroFlex® Restorative Elbow Orthosis

- Adjustable dials allow gradual changes to move joint toward normal alignment
- High-temperature, remouldable plastic cuffs
- Flex Technology splint moves with the patient's abnormal muscle tone/spasticity
- Padding provides comfort and redistributes skin pressure
- Brace provides 3-point leverage similar to manual stretching, improving range of motion
- Lower cuff swivels to allow for varying degrees of flexion



NeuroFlex® Restorative Elbow Orthosis

Size	Product Code	BTE	EFT	Circumference of Bicep	Circumference of Forearm
Child	RM0032	9cm	10cm	14 - 19cm	9 - 16.5cm
Youth	RM0034	10cm	12.5cm	16.5 - 21.5cm	12.5 - 19cm
Extra Small	RM0036	12.5cm	12.5cm	19 - 24cm	16.5 - 21.5cm
Small	RM0038	12.5cm	15cm	20 - 30cm	17.5 - 25.5cm
Medium	RM0040	15cm	15cm	20 - 33cm	19 - 28cm
Large	RM0042	16.5cm	16.5cm	25.5 - 38cm	20 - 30cm

Brace Orthopaedic CDS® Elbow Brace Extension (90° Hinge)

- Allows individual adjustment of spring tension
- Spring tension can be switched on and off without tools and without varying the set spring tension
- Infinitely variable adjustment of the correction range in extension between -15° and +30°
- Individual adjustment of shells in position and shape
- High wearing comfort due to air-permeable, light-weight aluminium shells



CDS® Elbow Brace Extension (90° Hinge)

Size	Product Code Left	Product Code Right	Length of Upper Arm Shell Medial	Circumference of Forearm Shell	Circumference of Upper Arm	Circumference of Forearm
Adult Small	906MM-L	906MM-R	17 - 20.5cm	19.5 - 22cm	20 - 30cm	18 - 24cm
Adult	906LL-L	906LL-R	18 - 22cm	21 - 26cm	28 - 39cm	22 - 30cm

Brace Orthopaedic CDS® Paediatric Elbow Brace Extension (90° Hinge)

- Allows individual adjustment of spring tension
- Spring tension can be switched on and off without tools and without varying the set spring tension
- Infinitely variable adjustment of the correction range in extension between -15° and +30°
- Individual adjustment of shells in position and shape
- High wearing comfort due to air-permeable, light-weight aluminium shells



CDS® Paediatric Elbow Brace Extension (90° Hinge)

Size	Product Code Left	Product Code Right	Length of Upper Arm Shell Medial	Circumference of Forearm Shell	Circumference of Upper Arm	Circumference of Forearm
Bambini*	906XSXS-L	906XSXS-R	14 - 17cm	14 - 17.5cm	12 - 17cm	12 - 14cm
Junior	906SS-L	906SS-R	17 - 20cm	17.5 - 20.5cm	15 - 21cm	14 - 19cm
Adolescent	906MM-L	906MM-R	17 - 20.5cm	19.5 - 22cm	20 - 30cm	18 - 24cm

*Bambini option has the 360° Nano Hinge.

Brace Orthopaedic CDS® Elbow Brace Flexion (360° Hinge)

- Allows individual adjustment of spring tension
- Spring tension can be switched on and off without tools and without varying the set spring tension
- Infinitely variable adjustment of the correction range in flexion
- Individual adjustment of shells in position and shape
- High wearing comfort due to air-permeable, light-weight aluminium shells



CDS® Elbow Brace Flexion (360° Hinge)

Size	Product Code Left	Product Code Right	Length of Upper Arm Shell Medial	Circumference of Forearm Shell	Circumference of Upper Arm	Circumference of Forearm
Adult Small	907MM-L	907MM-R	17 - 20.5cm	19.5 - 22cm	20 - 30cm	18 - 24cm
Adult	907LL-L	907LL-R	18 - 22cm	21 - 26cm	28 - 39cm	22 - 30cm

Brace Orthopaedic CDS® Paediatric Elbow Brace Flexion (360° Hinge)

- Allows individual adjustment of spring tension
- Spring tension can be switched on and off without tools and without varying the set spring tension
- Infinitely variable adjustment of the correction range in flexion
- Individual adjustment of shells in position and shape
- High wearing comfort due to air-permeable, light-weight aluminium shells



CDS® Paediatric Elbow Brace Flexion (360° Hinge)

Size	Product Code Left	Product Code Right	Length of Upper Arm Shell Medial	Circumference of Forearm Shell	Circumference of Upper Arm	Circumference of Forearm
Bambini*	907XSXS-L	907XSXS-R	14 - 17cm	14 - 17.5cm	12 - 17cm	12 - 14cm
Junior	907SS-L	907SS-R	17 - 20cm	17.5 - 20.5cm	15 - 21cm	14 - 19cm
Adolescent	907MM-L	907MM-R	17 - 20.5cm	19.5 - 22cm	20 - 30cm	18 - 24cm

*Bambini option has the 360° Nano Hinge.



Paediatric

Schein NovaPED Shell Like Full Length Available direct from Sheffield stock

- Cup shaped foot support, sandwich construction.
- Multiform multicolour cover



NovaPED Shell Like Full Length

Product Code	Size (EU)	Product Code	Size (EU)
982260-207-19/20	19/20	982260-207-35	35
982260-207-21/22	21/22	982260-207-36	36
982260-207-23/24	23/24	982260-207-37	37
982260-207-25/26	25/26	982260-207-38	38
982260-207-27/28	27/28	982260-207-39	39
982260-207-29/30	29/30	982260-207-40	40
982260-207-31/32	31/32	982260-207-41	41
982260-207-33/34	33/34	982260-207-42	42

Schein NovaPED Proprioceptive

- Proprioceptive sensorimotor treatments.



NovaPED Proprioceptive

Product Code	Size (EU)	Product Code	Size (EU)
952130-000-19/20	19/20	952130-000-35	35
952130-000-21/22	21/22	952130-000-36	36
952130-000-23/24	23/24	952130-000-37	37
952130-000-25/26	25/26	952130-000-38	38
952130-000-27/28	27/28	952130-000-39	39
952130-000-29/30	29/30	952130-000-40	40
952130-000-31/32	31/32	952130-000-41	41
952130-000-33/34	33/34	952130-000-42	42

Thuasne Sohli Paediatric Insoles Available direct from Sheffield stock

- Soft and flexible silicone heel cups
- For early treatment of children's pes valgus
- Heel bone support and horizontal heel reinforcement
- Lateral, elastic support edge

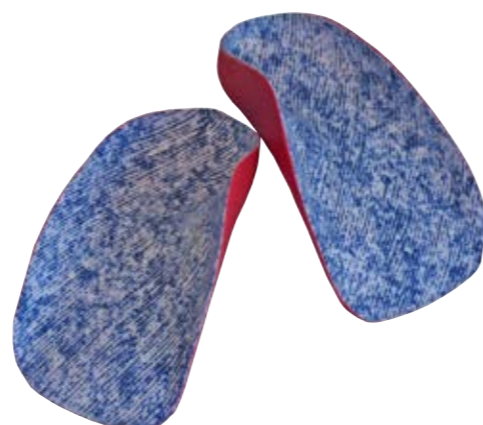

Sohli Paediatric Insoles (Pair)

Product Code	Size (EUR)	Product Code	Size (EUR)
T47984102002399	Sizes 19/20	T47984103002399	Sizes 29/30
T47984102202399	Sizes 21/22	T47984103202399	Sizes 31/32
T47984102402399	Sizes 23/24	T47984103402399	Sizes 33/34
T47984102602399	Sizes 25/26	T47984103602399	Sizes 35/36
T47984102802399	Sizes 27/28	T47984103802399	Sizes 37/38

Algeos Peapod Junior Available direct from Sheffield stock

- Space saving 1.5mm thermoplastic base
- Easily ground and heat mouldable at 130°
- Fabric top cover and supersoft edges to avoid irritation



Peapod Junior

Product Code	Size (UK)	Size (EUR)	Product Code	Size (UK)	Size (EUR)
SC2502	5	21/22	SC2512	13	31/32
SC2504	6.5	23/24	SC2514	1.5	33/34
SC2506	8	25/26	SC2516	3.5	35/36
SC2508	10	27/28	SC2518	5	37/38
SC2510	11.5	29/30	SC2520	6	39/40

Algeos Peapod Instant Neutral Available direct from Sheffield stock

- Combines a flat-based insole with an elevated wedge
- An ideal alternative to buying separate components



Peapod Instant Neutral

Product Code	Size (UK)	Size (EUR)
SC3388	4	19/20
SC3389	5	21/22
SC3390	6.5	23/24
SC3391	8	25/26
SC3392	9 - 10	27/28
SC3393	10 - 12	29/30
SC3394	13 - 1	31/32
SC3395	1 - 2	33/34

Algeos Peapod Instant 3 Degree Available direct from Sheffield stock

- Combines a flat-based insole with an elevated wedge
- An ideal alternative to buying separate components
- 3° posts



Instant 3 Degree

Product Code	Size (UK)	Size (EUR)
SC3370	4	19/20
SC3371	5	21/22
SC3372	6.5	23/24
SC3373	8	25/26
SC3374	9 - 10	27/28
SC3375	10 - 12	29/30
SC3376	13 - 1	31/32
SC3377	1 - 2	33/34

Algeos Peapod Instant 5 Degree Available direct from Sheffield stock

- Combines a flat-based insole with an elevated wedge
- An ideal alternative to buying separate components
- 5° posts



Instant 5 Degree

Product Code	Size (UK)	Size (EUR)
SC3379	4	19/20
SC3380	5	21/22
SC3381	6.5	23/24
SC3382	8	25/26
SC3383	9 - 10	27/28
SC3384	10 - 12	29/30
SC3385	13 - 1	31/32
SC3386	1 - 2	33/34

Thrive Orthopedics® F3 Hero Pediatric AFO Brace

- Dorsiflexion assist and Plantarflexion control
- Aerospace-grade carbon fibre construction
- Lightweight dynamic support with an enhanced, ultra-secure fit
- Thermal-formed, moisture-wicking padding with a tibia- relief channel for high levels of comfort
- Lateral strut design avoids contact with the ankle bone



Thrive Orthopedics® F3 Anterior AFO

Product Code Left	Product Code Right	Size	Footplate Length	Brace Height
PH-Hero-F3-LT-S F3	PH-Hero-F3-RT-S F3	Small	160mm	220mm
PH-Hero-F3-LT-M F3	PH-Hero-F3-RT-M F3	Medium	180mm	260mm
PH-Hero-F3-LT-L F3	PH-Hero-F3-RT-L F3	Large	200mm	295mm
PH-Hero-F3-LT-XL F3	PH-Hero-F3-RT-XL F3	Extra Large	210mm	315mm

Allard Boston Soft AFO

- Lightweight resting splint
- Inexpensive alternative to a custom AFO
- Manufactured from 3mm soft-feel polyethylene foam with a 3mm polypropylene heel insert
- Fully adjustable and easily trimmed with scissors



Allard Boston Soft AFO

Product Code - Paediatric with Stabiliser	Product Code - Paediatric without Stabiliser	Shoe Size (UK)	Shoe Size (EU)
AFO-P1S	AFO-P1	2-3	19-20
AFO-P2S	AFO-P2	4-5	21-22
AFO-P3S	AFO-P3	6-7	23-24
AFO-P4S	AFO-P4	8-9	25-26
AFO-P5S	AFO-P5	10-11	27-29
AFO-P6S	AFO-P6	12-13	30-31

Allard KiddieGAIT®

- Carbon composite with anterior shell, lateral strut and engineered footplate with open calcaneus
- Designed to allow integration of custom foot orthotic



Allard KiddieGAIT®

Left	Right	Description	Size	Footplate Length	Height
283721008	283722008	KiddieGAIT BABY	Baby Small	11cm	15cm
283721009	283722009	KiddieGAIT BABY	Baby Medium	12.5cm	18cm
283721010	283722010	KiddieGAIT BABY	Baby Large	14cm	20cm
289001011	289002011	KiddieGAIT Youth	Small	16cm	22cm
289001012	289002012	KiddieGAIT Youth	Medium	16cm	25.7cm
289001013	289002013	KiddieGAIT Youth	Large	20cm	29.5cm
289001014	289002014	KiddieGAIT Youth	Extra Large	21cm	31.5cm

Allard KiddieFLOW®

- KiddieFLOW™ is more flexible in the heel and toe area of the footplate than KiddieGAIT® and allows a greater range of motion
- Supports the dorsiflexion of the foot in the swing phase, provides better control of foot positioning in the late swing phase, which in turn improves stability in the stance phase
- Softer foot blade provides easier roll off at the end of the stance phase
- Can also be combined with individual insoles or SMO



Allard KiddieFLOW®

Left	Right	Size	Footplate Length	Height
288911011	288912011	Small	16cm	22cm
288911012	288912012	Medium	18cm	25.7cm
288911013	288912013	Large	20cm	29.5cm
288911014	288912014	Extra Large	21cm	31.5cm

Allard KiddieROCKER®

- Carbon composite with anterior shell, lateral strut and engineered footplate with open calcaneus
- Designed to allow integration of custom foot orthotic
- Offers extra rigidity that will enhance balance and posture control
- Developed for paediatric patients with more involved pathology than only footdrop



Allard KiddieGAIT®

Left	Right	Size	Footplate Length	Height
289021011	289022011	Small	16cm	22cm
289021012	289022012	Medium	18cm	25.7cm
289021013	289022013	Large	20cm	29.5cm
289021014	289022014	Extra Large	21cm	31.5cm

Anatomical Concepts PRAFO 450/550 Infant/Child

Available direct from Sheffield stock

- Zero heel pressure
- Ambulatory and recumbent use
- Also available with dual action
- Washable liner system



PRAFO 450/550 Size

450RKG - Infant	Infant 450
550SKG - Child	Child 550

Anatomical Concepts PRAFO Dual Action Kodel G-Metal

- In addition to plantar and dorsiflexion adjustment, this PRAFO accommodates and helps to control varus and valgus conditions of the ankle/ foot complex to + or - 30°
- Eliminates any pressure to the heel and the medial/lateral aspects of the malleoli
- Washable liner system



PRAFO Dual Action Kodel G-Metal Size

553SKG -	Child
----------	-------

Anatomical Concepts PRAFO Replacement Liners and Calf Strap

Available direct from Sheffield stock

- Replacement liners available for infant and child PRAFOs
- Replacement calf straps available for child PRAFOs



PRAFO Replacement Liners and Straps

Size	Product Code
Infant	L40RKG - Infant
Child	L50SKG - Child

Promedics Paediatric Walker



- Comfortable paediatric walker boot for stability and support
- Adjustable uprights for custom fit on lower limb, providing improved stability and immobilisation.
- Lightweight and durable sole unit improves shock absorption and gait pattern
- Robust foot section for improved wear
- Simple, secure hook and loop fastening
- Comfortable detachable liners with replacements available
- No-slip, rocker sole

Paediatric Walker

Size	Product Code	Shoe Size (UK) - Child
Small	PJWF/03	2 - 6
Medium	PJWF/05	7 - 10
Large	PJWF/07	11 - 13



Brace Orthopaedic Artisan Ankle+ Paediatric

- Unique pliable aluminium construction allows a 'custom fit' from a stock item
- Custom fit promotes patient compliance and comfort
- Shaping does not require the use of a heat gun, water bath, or removal of stays
- Lightweight and slim line profile
- Ability to re-shape and change ROM as required
- ROM can be changed in all planes, including frontal
- Features ventilation holes and increased padding
- Supplied with multiple straps



Artisan Ankle+ Paediatric

Size	Measurement	Product Code	Left/Right
Small Paediatric	Shoe Size (UK) < 10.5	55020-0	Universal
Paediatric	Shoe Size (UK) 10.5 - 2	55021-0	Universal

Beagle Paediatric UFO Ankle Brace Available direct from Sheffield stock

- Prefabricated night splint for the effective treatment of plantar fasciitis and achilles tendonitis
- Comfortably supports the foot in a controlled amount of dorsiflexion, applying a Low Load Prolonged Stretch (LLPS)
- LLPS promotes gentle stretching, healing and re-modeling of tissues
- Adjustable bilateral dorsiflexion assist straps
- CoolFoam™ replaceable liner wicks moisture away from the skin for enhanced hygiene
- Universal - fits left or right

Paediatric UFO Ankle Brace

Product Code	Size	Brace Height	Footplate Length
B/3614	Small	165mm	140mm
B/3615	Medium	250mm	170mm
B/3616	Large	265mm	190mm



Ossur DynaPro® AFO

- Effectively reverses ankle/foot contractures
- Elastic pull straps effectively treat plantar flexion, inversion or eversion
- Non-skid bottom for assisted transfers

DynaPro® AFO

Product Code	Size	Foot Length	Max. Calf Circumference
DPAFO24C	Child	9 - 13cm	30cm
DPAFO25Y	Youth	13 - 15cm	36cm



Allard SureStep Go SMO

- A prefabricated SMO, designed to manage mild to severe pronation associated with hypotonia
- Uses circumferential compression to stabilise the foot and ankle
- Open heel allows more of the foot to "feel the floor", which aids in sensory input and posture
- For maximum function, always wear with suitable footwear
- Highly recommended to be used together with KiddieFLOW™, KiddieGAIT® or KiddieROCKER®

Allard SureStep Go SMO

Size	Product Code - Pair	Product Code - Left	Product Code - Right	UK Shoe Size	EU Shoe Size
3T	287400003	287421003	287422003	2	19
4T	287400004	287421004	287422004	4	20
5T	287400005	287421005	287422005	5	21
6T	287400006	287421006	287422006	5.5	22
7T	287400007	287421007	287422007	6	23
8T	287400008	287421008	287422008	7	24
9T	287400009	287421009	287422009	8.5	26
10Y	287410010	287431010	287432010	9	27
11Y	287410011	287431011	287432011	10	28
12Y	287410012	287431012	287432012	11	29



Cascade DAFO JumpStart® Bunny®

- High proximal “ears” provide additional medial/lateral control
- Proximal posterior elastic strap adds to frontal plane control and offers mild resistance to excess plantarflexion.
- Option to replace posterior strap with anterior/posterior wrap-around strap
- Solid outer foundation provides additional support and heel stabilisation
- Full wrap inner liner made from soft, thin polyethylene plastic allows full alignment control of the heel, mid-foot, and forefoot
- Choice of two outer foundation materials - polyethylene for moderate flexibility or co-poly for firm support



Cascade DAFO JumpStart® Bunny®

Description	Product Code Narrow Fitting - Blue	Product Code Narrow Fitting - Pink	Product Code Wide Fitting - Blue	Product Code Wide Fitting - Pink
Left	JSBUNNY/N/B/LT-Size	JSBUNNY/N/P/LT-Size	JSBUNNY/W/B/LT-Size	JSBUNNY/W/P/LT-Size
Right	JSBUNNY/N/B/RT-Size	JSBUNNY/N/P/RT-Size	JSBUNNY/W/B/RT-Size	JSBUNNY/W/P/RT-Size
Pair	JSBUNNY/N/B-Size	JSBUNNY/N/P-Size	JSBUNNY/W/B-Size	JSBUNNY/W/P-Size

Cascade DAFO JumpStart® Leap Frog®

- Open ankle trimline allows for free dorsiflexion and plantarflexion movement
- Solid outer foundation provides additional support and heel stabilization
- Full wrap inner liner made from soft, thin polyethylene plastic allows full alignment control of the heel, mid-foot, and forefoot
- Choice of two outer foundation materials - polyethylene for moderate flexibility or co-poly for firm support



Cascade DAFO JumpStart® Leap Frog®

Description	Product Code Narrow Fitting - Blue	Product Code Narrow Fitting - Pink	Product Code Wide Fitting - Blue	Product Code Wide Fitting - Pink
Left	JSLEAPFROG/N/B/LT-Size	JSLEAPFROG/N/P/LT-Size	JSLEAPFROG/W/B/LT-Size	JSLEAPFROG/W/P/LT-Size
Right	JSLEAPFROG/N/B/RT-Size	JSLEAPFROG/N/P/RT-Size	JSLEAPFROG/W/B/RT-Size	JSLEAPFROG/W/P/RT-Size
Pair	JSLEAPFROG/N/B-Size	JSLEAPFROG/N/P-Size	JSLEAPFROG/W/B-Size	JSLEAPFROG/W/P-Size

Cascade DAFO JumpStart® Kangaroo®

- Open anterior allows access to free dorsiflexion
- Solid outer foundation and posterior leg portion add extra arch support, heel stability, and strength to block excess plantarflexion
- Full wrap inner liner made from soft, thin polyethylene plastic allows full alignment control of the heel, mid-foot, and forefoot
- Choice of two outer foundation materials - polyethylene for moderate flexibility or co-poly for firm support
- Optional Super Heel Seating Strap provides additional plantarflexion block and heel control



Cascade DAFO JumpStart® Kangaroo®

Description	Product Code Narrow Fitting - Blue	Product Code Narrow Fitting - Pink	Product Code Wide Fitting - Blue	Product Code Wide Fitting - Pink
Left	JSKANGAROO/N/B/LT-Size	JSKANGAROO/N/P/LT-Size	JSKANGAROO/W/B/LT-Size	JSKANGAROO/W/P/LT-Size
Right	JSKANGAROO/N/B/RT-Size	JSKANGAROO/N/P/RT-Size	JSKANGAROO/W/B/RT-Size	JSKANGAROO/W/P/RT-Size
Pair	JSKANGAROO/N/B-Size	JSKANGAROO/N/P-Size	JSKANGAROO/W/B-Size	JSKANGAROO/W/P-Size

Cascade DAFO JumpStart® Softback®

- Soft yet durable padding sewn to flexible Dacron strap strongly resists excess PF and encourages free DF
- Dacron strap attaches to outer frame for durability
- Full-wrap inner liner provides alignment control of the heel, midfoot, and forefoot.
- Inner liner tucks behind the padding for added comfort
- Solid outer foundation provides additional support and heel stabilization.
- Available in polyethylene for moderate flexibility or co-poly for firm support



Cascade DAFO JumpStart® Softback®

Description	Product Code Narrow Fitting - Blue	Product Code Narrow Fitting - Pink	Product Code Wide Fitting - Blue	Product Code Wide Fitting - Pink
Left	JSSOFTBACK/N/B/LT-Size	JSSOFTBACK/N/P/LT-Size	JSSOFTBACK/W/B/LT-Size	JSSOFTBACK/W/P/LT-Size
Right	JSSOFTBACK/N/B/RT-Size	JSSOFTBACK/N/P/RT-Size	JSSOFTBACK/W/B/RT-Size	JSSOFTBACK/W/P/RT-Size
Pair	JSSOFTBACK/N/B-Size	JSSOFTBACK/N/P-Size	JSSOFTBACK/W/B-Size	JSSOFTBACK/W/P-Size

Orthotix Orliman Penguin Plantarflexion AFO Standard

- Dynamic orthosis made of flexible thermoplastic
- Internal, low density thermoplastic (LDPE) covers the back of the leg, enclosing the entire perimeter of the midfoot to ensure correct fit
- More rigid external thermoplastic (PP) provides firm support to control the biomechanical positioning and alignment of the limb
- Hook and loop closure system enhances comfort and fit
- Lightweight with a trimmable hem
- Low profile design is easy to adjust in the shoe
- Includes pads for the toes and the dorsal midfoot



Orthotix Penguin Plantarflexion AFO Standard

Size	Foot Length	Height	Product Code Left	Product Code Right
1	12.4cm	12.2cm	OP1195/L/1	OP1195/R/1
2	13.2cm	12.7cm	OP1195/L/2	OP1195/R/2
3	14cm	13.5cm	OP1195/L/3	OP1195/R/3
4	15cm	14.5cm	OP1195/L/4	OP1195/R/4
5	16cm	15.5cm	OP1195/L/5	OP1195/R/5
6	17.5cm	17cm	OP1195/L/6	OP1195/R/6
7	19cm	18.5cm	OP1195/L/7	OP1195/R/7
8	21cm	20.5cm	OP1195/L/8	OP1195/R/8

Orthotix Orliman Penguin Plantarflexion AFO Extended

- Dynamic orthosis made of flexible thermoplastic
- Internal, low density thermoplastic (LDPE) covers the back of the leg, enclosing the entire perimeter of the midfoot to ensure correct fit
- More rigid external thermoplastic (PP) provides firm support to control the biomechanical positioning and alignment of the limb
- Hook and loop closure system enhances comfort and fit
- Lightweight with a trimmable hem
- Low profile design is easy to adjust in the shoe
- Includes pads for the toes and the dorsal midfoot



Orthotix Penguin Plantarflexion AFO Extended

Size	Product Code Left	Product Code Right	Foot Length	Height
1	OP1198/L/1	OP1198/R/1	12.4cm	16.5cm
2	OP1198/L/2	OP1198/R/2	13.2cm	17.4cm
3	OP1198/L/3	OP1198/R/3	14cm	18.3cm
4	OP1198/L/4	OP1198/R/4	15cm	19.2cm
5	OP1198/L/5	OP1198/R/5	16cm	20.7cm
6	OP1198/L/6	OP1198/R/6	17.5cm	22.2cm
7	OP1198/L/7	OP1198/R/7	19cm	24cm
8	OP1198/L/8	OP1198/R/8	21cm	26cm

Orthotix Orliman Puffin Dynamix Supramalleolar AFO Available direct from Sheffield stock

- Made from low density polyethylene and polypropylene
- Midfoot hook and loop closure system with straps that can be cut to desired length
- Adhesive hook and loop patches between the shells prevent any movement
- Optional comfort pads for the toe and dorsal midfoot regions included
- Adjustable and trimmable lightweight design



When fitting it is recommended to choose a size that leaves approximately 1cm of space between the end of the orthosis and the foot.

Puffin Dynamix Supramalleolar AFO

Size	Foot Length	Height	Product Code Left	Product Code Right
1	12.5cm	7.9cm	OP1196/L/1	OP1196/R/1
2	13.5cm	8.3cm	OP1196/L/2	OP1196/R/2
3	14cm	8.6cm	OP1196/L/3	OP1196/R/3
4	15cm	9cm	OP1196/L/4	OP1196/R/4
5	16cm	9.4cm	OP1196/L/5	OP1196/R/5
6	17.5cm	9.8cm	OP1196/L/6	OP1196/R/6
7	19cm	10.2cm	OP1196/L/7	OP1196/R/7
8	21cm	10.8cm	OP1196/L/8	OP1196/R/8

Orthotix Orliman Pelican Hinged AFO

- Controls plantarflexion and toe walking
- Realigns entire foot and supports the medial longitudinal arch
- Facilitates the development of movement patterns for a more natural gait
- Increased control of knee hyperextension
- Ankle angle can be adjusted using posterior screw (Allen key provided)
- Low profile design for ease of accommodation in patient's footwear
- Prefabricated for instant use and sized by simple foot measurement



Orthotix Pelican Hinged AFO

Size	Foot Length	Height	Product Code Left	Product Code Right
1	12.5cm	12.2cm	OP1197/L/1	OP1197/R/1
2	13cm	12.7cm	OP1197/L/2	OP1197/R/2
3	14cm	13.5cm	OP1197/L/3	OP1197/R/3
4	15cm	14.5cm	OP1197/L/4	OP1197/R/4
5	16cm	15.5cm	OP1197/L/5	OP1197/R/5
6	17.5cm	17cm	OP1197/L/6	OP1197/R/6
7	19cm	24cm	OP1198/L/7	OP1198/R/7
8	21cm	20.5cm	OP1197/L/8	OP1197/R/8

Orthotix Orliman Piper Inframalleolar Foot Orthosis

- A two shell dynamic Inframalleolar foot orthosis, made from dual density materials
- Deep heel cup design for optimised calcaneal control
- Realignment of the hindfoot and midfoot, improving mediolateral stability
- Stabilisation of the foot through the coronal plane and medial longitudinal arch
- Facilitates a more natural gait pattern, soft and pressure relieving against skin
- A cosmetic and low profile design in comparison to custom made foot orthosis
- Soft and pressure relieving against skin

Orthotix Orliman Piper Inframalleolar Foot Orthosis

Size	Foot Length	Shoe Size (UK) - Child	Product Code Left	Product Code Right
1	12.5cm	5	OP1199/L/1	OP1199/R/1
2	13cm	6	OP1199/L/2	OP1199/R/2
3	14cm	6.5	OP1199/L/3	OP1199/R/3
4	15cm	8	OP1199/L/4	OP1199/R/4
5	16cm	9	OP1199/L/5	OP1199/R/5
6	17.5cm	10.5	OP1199/L/6	OP1199/R/6
7	19cm	12	OP1199/L/7	OP1199/R/7
8	21cm	2 (Adult)	OP1199/L/8	OP1199/R/8



Orthotix Orliman Parrot Open-Back AFO

- A two shell dynamic open backed orthosis, made from dual density materials
- Control for plantarflexion enabling improved foot clearance during swing phase
- Posterior cut out and adjustable ankle strap allows for increased shank inclination
- Supramalleolar containment and dorsal midfoot enclosure improve mediolateral stability
- Open back with semi rigid ankle strapping improves stance alignment whilst enabling a controlled movement up and down slopes and stairs.
- A cosmetic and low profile design in comparison to custom made orthosis
- Soft and pressure relieving against skin

Orthotix Orliman Piper Inframalleolar Foot Orthosis

Size	Foot Length	Height	Shoe Size (UK) - Child	Product Code Left	Product Code Right
1	12.5cm	10.5cm	5	OP11910/L/1	OP11910/R/1
2	13cm	11cm	6	OP11910/L/2	OP11910/R/2
3	14cm	11.5cm	6.5	OP11910/L/3	OP11910/R/3
4	15cm	12cm	8	OP11910/L/4	OP11910/R/4
5	16cm	12.5cm	9	OP11910/L/5	OP11910/R/5
6	17.5cm	13.5cm	10.5	OP11910/L/6	OP11910/R/6
7	19cm	14.5cm	12	OP11910/L/7	OP11910/R/7
8	21cm	15.5cm	2 (Adult)	OP11910/L/8	OP11910/R/8



Beagle Aequi Ankle Junior (Push Ortho)

- Stabilises the ankle joint during inversion as well as eversion and in both neutral and flexed positions
- The shell provides optimal support for the ankle in a simple and comfortable manner
- Diagonal straps made of non-elastic material provide the correct compression
- Molecule symbols helps the wearer to fasten the straps correctly and in the right sequence
- Universal: the brace can be worn on either the left or right side



Beagle Aequi Ankle Junior (Push Ortho)

Size	Product Code
Universal	PUS100B

Beagle Orthomerica Paediatric AFO PLS

- Popular prefabricated design accommodates many patients not requiring a custom or more rigid AFO
- Full range of sizes fits infants 2 months to 6 years
- Low-profile, effective for most indications
- Inexpensive, labour savings for office or clinical application



Beagle Orthomerica Paediatric AFO PLS

Size	Product Code Left	Product Code Right	Calf Circumference	Foot Length	Brace Height
Extra Small	B/3581	B/3586	152 - 190mm	101mm	165mm
Small	B/3582	B/3587	190 - 228m	114mm	190mm
Medium	B/3583	B/3588	215 - 241mm	120mm	228mm
Large	B/3584	B/3589	228 - 226mm	133mm	254mm
Extra Large	B/3585	B/3590	254 - 292m	152mm	279mm

Turtlebrace Baby

- 'Apply and forget' type brace made of a stratification of multi-perforated low-temperature thermoplastic and microfibre fabric
- Flexibility of components stabilises joint more easily and precisely than a traditional brace or cast
- Can be reshaped multiple times, without losing its qualities - allows adjustment due to swelling or morphological changes



Turtlebrace Baby

Age/Size	Product Code	Calf Circumference	Ankle Circumference	Height
1 Month	TBBC-01	Min: 12.6cm Max: 15.8cm	Min: 10.8cm Max: 13.4cm	11cm
6 Months	TBBC-02	Min: 16.2cm Max: 20.5cm	Min: 12.6cm Max: 15.8cm	15cm
18 Months	TBBC-03	Min: 19.8cm Max: 25.1cm	Min: 14.4cm Max: 18.1cm	19cm



Turtlebrace Ankle

- 'Apply and forget' type brace made of a stratification of multi perforated low-temperature thermoplastic and microfibre fabric
- Flexibility of components stabilises joint more easily and precisely than a traditional brace or cast
- Can be reshaped multiple times, without losing its qualities - allows adjustment due to swelling or morphological changes



Turtlebrace Ankle

Size	Product Code - Standard	Product Code - Reinforced	Ankle Circumference
Paediatric - Small	TBCP-01	N/A	16.5cm - 27.6cm
Paediatric - Medium	TBCP-02	TBCPR-02	17.8cm - 29.8cm
Paediatric - Large	TBCP-03	TBCPR-03	19cm - 31.8cm



Ossur Rebound® Post-op Available direct from Sheffield stock

- Tool-free design and multi-purpose Smart-Fit™ packaging
- Available in universal, left or right contour and pediatric
- Telescoping frame from 47 - 69cm
- OneTouch™ easy to adjust ROM hinge with lock-out capability
- Color-coding and numbered frame for patient education
- Quick-fit, gripping buckles for easy application



Ossur Rebound® Post-op

Size	Thigh Circumference	Product Code Cool
Paediatric	30.5 - 63.5cm	B-8381470

Brace Orthopaedic Paediatric Hypex® Lite Knee Brace

- Knee orthosis with 4 point principle and extension/flexion limitations
- Physiological motion sequence through combined arrangement of joints
- Anatomically formed joint rods and shells
- Limits may be adjusted without tools
- Continuously adjustable extension between +45° and -15° to allow for physiological hyperextension of the knee
- Flexion can be adjusted in 15° intervals up to 90° (max flexion 130°)
- Continuous immobilisation between +45° and -15°
- Easy handling and high wearing comfort



Brace Orthopaedic Paediatric Hypex® Lite Knee Brace - Black

Size	Product Code - Left	Product Code - Right	Thigh Circumference	Lower Leg Circumference
Malinki	804XXS-L	804XXS-R	18 - 22cm	17 - 20cm
Bambini	804XSXS-L	804XSXS-R	18 - 23cm	21 - 30cm
Junior	804SS-L	804SS-R	30 - 36cm	22 - 32cm

Medi ROM Kidz

- Universal children's knee brace with flexion and extension stops for mobilisation
- High level of wearing comfort thanks to the trimmable pads
- Good fit due to the individually adjustable, wide straps
- Modern design and denim colour



Medi Kidz ROM

Size	Product Code 25cm Length	Product Code 35cm Length
Universal	K844/2	K844/4

Promedics Fun Pattern Arm and Knee Gaiter Available direct from Sheffield stock

- Hard wearing fun print material
- Wrap-around with hook and loop closures
- Three rigid stays for effective immobilisation
- Please quote required length of brace after product code
- After each code please specify choice of fabric from below
- Patterns may vary, but will be age/gender appropriate

Fabrics available:



Code E Code F Code G Code K Code L

Fun Pattern Arm and Knee Gaiter

Size	Code	Length	Circumference (Top)	Circumference (Bottom)
1	FPI8/02/*	20cm	17 - 24cm	12 - 19cm
2	FPI8/03/*	20cm	23 - 30cm	14 - 21cm
3	FPI10/02/*	25cm	17 - 24cm	12 - 19cm
4	FPI10/03/*	25cm	23 - 30cm	14 - 21cm
5	FPI12/03/*	30cm	23 - 30cm	14 - 21cm
6	FPI12/05/*	30cm	30 - 37cm	17 - 24cm
7	FPI14/05/*	35cm	30 - 37cm	17 - 24cm
8	FPI16/07/*	40cm	37 - 44cm	20 - 27cm
9	FPI18/07/*	45cm	37 - 44cm	20 - 27cm
10	FPI18/08/*	45cm	44 - 51cm	23 - 30cm
11	FPI20/07/*	50cm	37 - 44cm	20 - 27cm
12	FPI20/08/*	50cm	44 - 51cm	23 - 30cm

* Add one of the codes below for fabric selection: (e.g. Size 2, with fabric code 'K' = FPI8/03/K)



Orthotix Derotation Orthosis

- Designed to assist with correction of internal/external rotation of both lower limbs, enabling feet to be in the line of progression during gait
- Consists of a belt and two unidirectional elastic straps featuring silicone pimples for improved anatomical adhesion. Straps apply spiral traction from medial side of the foot to the waist, rotating the tibia, femur and hip in the desired corrective direction
- If internal rotation is required simply swap over the left and right straps for the desired effect



Orthotix Double Derotation Orthosis

Size	Product Code	Waist Circumference	Strap Length
Extra Small	OP1173/0	44 - 50cm	120cm
Small	OP1173/1	48 - 55cm	120cm
Medium	OP1173/2	52 - 61cm	142cm
Large	OP1173/3	56 - 65cm	164.5cm
Extra Large	OP1173/4	62 - 71cm	187cm

Orthotix Single Derotation Orthosis

Size	Product Code - Left	Product Code - Right	Waist Circumference	Strap Length
Small	OP1174I/1	OP1174D/1	48 - 55cm	120cm
Medium	OP1174I/2	OP1174D/2	52 - 61cm	142cm
Large	OP1174I/3	OP1174D/3	56 - 65cm	164.5cm
Extra Large	OP1174I/4	OP1174D/4	62 - 71cm	187cm



Promedics Pavlik Harness Available direct from Sheffield stock

- Controls hip flexion and abduction in the primary treatment of congenital dislocation of the hips
- Colourful strap identification with adjustable hook and loop closures
- Padded harness with a unique reversible toe cover, which can be worn open or closed toe



Pavlik Harness

Size	Product Code	Age (Months)	Chest Circumference
Extra Small	PAV/02	0 - 3	30 - 36cm
Small	PAV/03	3 - 6	36 - 42cm
Medium	PAV/05	6 - 9	39 - 45cm
Large	PAV/07	9 - 12	46 - 55cm
Extra Large	PAV/08	12 +	56 - 59cm

Promedics CDH Hip Brace

- Lightweight, rigid polypropylene frame
- Lined with hygienic, non- absorbant, closed cell foam padding
- Maintain legs in 90 degrees hip flexion and up to 60 degrees of abduction



Promedics CDH Hip Brace

Size	Product Code	Age (Months)
Extra Small	FCDH/02	6-12lb
Small	FCDH/03	13-16lb
Medium	FCDH/05	17-21lb
Extra Large	FCDH/07	2-30lb

Wheaton Pavlik Harness Available direct from Sheffield stock

- Pavlik harness specially designed for infant and child hip dysplasia
- Harness allows movement in a controlled manner
- Hook and loop fasteners allow for rapid and secure adjustment
- Colour coded straps help to avoid misapplication
- Anti-slip footpiece prevents the foot from slipping out of the harness



Wheaton Pavlik Harness

Size	Product Code	Age (Months)	Chest Circumference
Extra Small	NSE887-XS	0	30 - 36cm
Small	NSE887-S	0 - 3	36 - 41cm
Medium	NSE887-M	3 - 6	41 - 46cm
Large	NSE887-L	6 - 9	46 - 53cm
Extra Large	NSE887-XL	9 +	53cm +

Boston Hip Abduction Brace

- Lightweight frame manufactured using sturdy polypropylene and a closed cell, hypoallergenic foam liner which does not retain moisture
- Maintains concentric reduction of hips in paediatric dysplasia
- Can replace spica casts and harnesses for certain developmental dysplasias
- Easy to apply and convenient for nappy changes
- Easily cleaned with soap and water



Boston Hip Abduction Brace

Size	Product Code	Pelvic Circumference
Extra Extra Small	HPXXS	26 - 30cm
Extra Small	HPXS	30 - 38cm
Small	HPS	38 - 46cm
Medium	HPM	46 - 51cm
Large	HPL	51 - 56cm

Promedics Pro Tem Belt

- Paediatric lumbar support
- Used effectively in the management of abnormal tone by providing proximal stability and improving proprioceptive feedback



Protem Belt

Size	Product Code	Waist Circumference
Extra Extra Small	TBP/01	46 - 54cm
Extra Small	TBP/02	56 - 64cm

Promedics Paediatric Wrist Splint

- Manufactured in Lycrafleece™ material
- Colourful hook and loop design
- 15 cm depth

Paediatric Wrist Splint

Size	Code (Left)	Code (Right)	Wrist Circumference
Extra Small	PLWB/12	PLWB/22	12 - 13cm
Small	PLWB/13	PLWB/23	13 - 14cm
Medium	PLWB/15	PLWB/25	14 - 15cm
Large	PLWB/17	PLWB/27	15 - 17cm
Extra Large	PLWB/18	PLWB/28	17 - 18cm



Lycrafleece™

Promedics Paediatric Elastic Wrist Brace

- Manufactured in single compression elastic
- Contrasting colourful bar casing and edge binding
- 15cm length
- **Contains latex**

Paediatric Elastic Wrist Brace

Size	Code (Left)	Code (Right)	Wrist Circumference
1	PEW/13	PEW/23	11.5cm
2	PEW/15	PEW/25	14.5cm
3	PEW/17	PEW/27	16cm



Promedics Paediatric Neoprene Wrist Brace

- Manufactured in a range of coloured Neoprene
- Contrasting colourful bar casing and hook and loop fastening
- 15 cm length

Paediatric Neoprene Wrist Brace

Size	Colour	Code (Left)	Code (Right)	Wrist Circumference
Small	Black	PNW/13/BK	PNW/23/BK	11.5cm
Medium	Black	PNW/15/BK	PNW/25/BK	14.5cm
Large	Black	PNW/17/BK	PNW/27/BK	16cm
Small	Red	PNW/13/RD	PNW/23/RD	11.5cm
Medium	Red	PNW/15/RD	PNW/25/RD	14.5cm
Large	Red	PNW/17/RD	PNW/27/RD	16cm



Promedics Tracy Brace

- Made of quality woven elastic for comfort and durability, enclosing an aluminium palmar bar, which can be easily removed
- The design is cut below the palmar crease and will not impinge on the MCP joints allowing for a fully functional hand
- Length is 14-15cm

Tracy Brace

Size	Code (Left)	Code (Right)	Wrist Circumference
Small	TWB/13	TWB/23	12cm
Medium	TWB/15	TWB/25	14cm
Large	TWB/17	TWB/27	16cm



Turtlebrace Wrist

- 'Apply and forget' type brace made of a stratification of multi-perforated low-temperature thermoplastic and microfibre fabric
- Flexibility of components stabilises joint more easily and precisely than a traditional brace or cast
- Can be reshaped multiple times, without losing its qualities - allows adjustment due to swelling or morphological changes

Turtlebrace Wrist

Size	Product Code - Hook and Loop	Product Code - Zipper	Wrist Circumference
Paediatric - Medium	TBPPV-02	TBPPZ-02	10.4cm - 16.6cm
Paediatric - Large	TBPPV-03	TBPPZ-03	12.8cm - 20.5cm



Turtlebrace Finger Add-ons

- Auto-fusing finger extension that can be applied on the popular Turtlebrace wrist or the Harebrace wrist
- Unique design facilitates immobilisation where required
- Flexibility of components stabilises fingers more easily and precisely than a traditional brace or cast
- Can be cut to fit
- Can be reshaped multiple times, without losing its qualities - allows adjustment due to morphological changes or specific protocols
- Universal size
- Universal Finger Splint can be used to splint fractured fingers when a wrist brace is not required

Turtlebrace Finger Add-ons

Size	Product Code - Fingers	Product Code - Thumb
Universal	EDUA	EPUA



Turtlebrace Finger Splint

Size	Product Code
Universal	DUA



Promedics Paediatric Wrist/Thumb Splint

- Manufactured in Lycrafleece™ material
- Colourful hook and loop design
- 15 cm depth



Paediatric Wrist/Thumb Splint

Size	Code (Left)	Code (Right)	Wrist Circumference
Extra Small	PLWTB/12	PLWTB/22	12 - 13cm
Small	PLWTB/13	PLWTB/23	13 - 14cm
Medium	PLWTB/15	PLWTB/25	14 - 15cm
Large	PLWTB/17	PLWTB/27	15 - 17cm
Extra Large	PLWTB/18	PLWTB/28	17 - 18cm

Lycrafleece™

Promedics Junior Wrist/Thumb Brace

- Made of Neoprene, which can be cut without fraying to fit around swollen joints, giving compression and excellent conformity
- Incorporates a malleable metal thumb stay to control an unstable CMC joint; the thumb section can be trimmed to allow IP flexion



Junior Wrist/Thumb Brace

Size	Code (Left)	Code (Right)	Wrist Circumference	Palmar Bar Length
Small	JWTO/13	JWTO/23	12cm	14cm
Medium	JWTO/15	JWTO/25	14cm	14cm
Large	JWTO/17	JWTO/27	16cm	16cm

Promedics Paediatric Elastic Wrist/Thumb Brace

- Manufactured in single compression blue elastic
- Contrasting colourful bar casing and edge binding
- 15cm length
- Contains latex



Paediatric Elastic Wrist/Thumb Brace

Size	Code (Left)	Code (Right)	Wrist Circumference
1	PEWT/13	PEWT/23	11.5cm
2	PEWT/15	PEWT/25	14.5cm
3	PEWT/17	PEWT/27	16cm

Promedics Paediatric Thumb Spica

- Manufactured in Lycrafleece™ material
- Colourful hook and loop design
- Flexible splint to support thumb and provide greater comfort with thumb movement



Paediatric Thumb Spica

Size	Code (Left)	Code (Right)	Wrist Circumference
Extra Small	PLTS/12	PLTS/22	12 - 13cm
Small	PLTS/13	PLTS/23	13 - 14cm
Medium	PLTS/15	PLTS/25	14 - 15cm
Large	PLTS/17	PLTS/27	15 - 17cm
Extra Large	PLTS/18	PLTS/28	17 - 18cm

Lycrafleece™

Promedics Neoprene Wrist/Thumb Brace

- Manufactured in a range of coloured Neoprene
- Contrasting colourful bar casing and hook and loop fastening
- 15 cm length



Neoprene Wrist/Thumb Brace

Size	Colour	Code (Left)	Code (Right)	Wrist Circumference
1	Black	PNWT/13/BK	PNWT/23/BK	11.5 cm
2	Black	PNWT/15/BK	PNWT/25/BK	14.5 cm
3	Black	PNWT/17/BK	PNWT/27/BK	16 cm



Brace Orthopaedic Artisan Palmar Forearm Splint Paediatric

- Immobilisation of the wrist, thumb and fingers, pre-operatively, post-operatively, or for the management of fractures, including replacement of previously fitted plaster cast



Artisan Palmar Forearm Splint - Paediatric

Size	Measurement	Product Code	Left/Right
Paediatric	Tip of middle finger to wrist <16cm	55010	Universal

Ossur SoftPro® Functional Resting WHFO Available direct from Sheffield stock

- Color coded straps
- Extra long wrist strap holds the wrist in the proper position and applies a gentle stretch
- "Bend to Fit" – easily adjust to correct alignment and support joints without the use of a heat gun



SoftPro® Functional Resting WHFO

Size	Left	Right	Width of MT Joints	Length
Child	SP31FFR-C-L	SP31FFR-C-R	4 - 5cm	18cm
Youth	SP31FFR-Y-L	SP31FFR-Y-R	5 - 6cm	20cm

NeuroFlex® Restorative Paediatric ThumbEase

- Wrist strap placement efficiently addresses wrist drop
- Wide strap conforms over the fingers and the back of the hand comfortably
- Thumb pocket without rigid base allows for use on severely contracted thumbs
- Lightweight and padded support
- Padding can be added for the gradual abduction of deformed thumbs
- Flex Technology splint moves with the patient's abnormal muscle tone and spasticity
- High-temperature, remouldable plastic base



NeuroFlex® Restorative Paediatric ThumbEase

Size	Left	Right	Width of MCP	Wrist to Finger Measurement	Wrist to Forearm Measurement
Toddler	RM0065	RM0067	5 - 5.5cm	Up to 9cm	9cm
Child	RM0069	RM0073	5.5 - 6.5cm	Up to 10cm	9.5cm
Youth	RM0133	RM0135	7 - 7.5cm	Up to 12.5	10cm

Allard S.O.T. Resting Splint

- Smooth and lightweight with an aluminium core allowing adjustment to the desired position
- The aluminium core is embedded into polyethylene foam and covered with fabric
- Accessories available: - Additional cover - Extra wrist strap - Finger divider - MCP wedges in three sizes



S.O.T. Resting Splint

Size	Product Code Left	Product Code Right	MCP Width	Wrist to Finger Tip
Extra Extra Extra Small	287101008	287102008	5.5cm	≤ 12cm
Extra Extra Small	287101009	287102009	≤ 6.5cm	≤ 14cm
Extra Small	287101010	287102010	≤ 7.5cm	≤ 16cm
Small	287101011	287102011	≤ 7.5cm	≤ 18.5cm

Additional Cover

Size	Product Code Left	Product Code Right
Extra Extra Extra Small	287141008	287142008
Extra Extra Small	287141009	287142009
Extra Small	287141010	287142010
Small	287141011	287142011

MCP Wedge

Size (Bilateral)	Product Code	MCP Width	Wrist to Finger Tip
Extra Extra Small	287110009	65mm	10mm
Extra Small	287110011	75mm	15mm

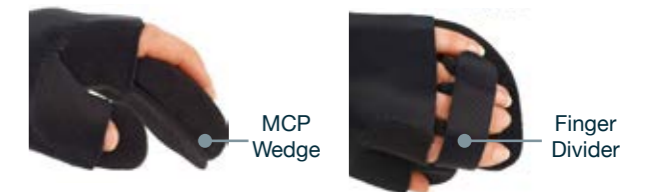

Extra Strap

Size (Bilateral)	Product Code
Extra Extra Extra Small - Extra Small	287130009
Small - Large	287130012

Finger Divider

Size (Bilateral)	Product Code
Paediatric	287120003

Promedics Paediatric Lancaster Shoulder Brace

- Universal adjustable sling with shoulder strap and body wrap for shoulder immobilisation
- Arm envelope can be easily trimmed for custom-fit
- Fully adjustable shoulder strap with padded sleeve for comfort around neck
- Easily adjusted to fit most paediatric patients



Paediatric Lancaster Shoulder Brace

Size	Product Code	Age
Baby	LSSB/10	0 - 18 Months
Paediatric	LSSP/10	2 - 10 Years

Promedics Paediatric Trauma Sling

- High quality universal sling that has multiple uses within the healthcare field
- Can be used as a traditional sling or for arm elevation following trauma, burns or post-operative management of the shoulder or upper arm
- Design and quality materials used offer protection, comfort and ease of access to the damaged limb
- Easy to apply and is supplied vacuum packed to reduce storage volume



Paediatric Lancaster Shoulder Brace

Size	Product Code
One Size	TAU/P

Turtlebrace Elbow

- 'Apply and forget' type brace made of a stratification of multi-perforated low-temperature thermoplastic and microfibre fabric
- Flexibility of components stabilises joint more easily and precisely than a traditional brace or cast
- Can be reshaped multiple times, without losing its qualities - allows adjustment due to swelling or morphological changes



Turtlebrace Elbow

Age/Size	Product Code	Arm Circumference	Wrist Circumference	Total Length
1 month	TBBCo-01	Min: 10.8cm Max: 13.4cm	Min: 9cm Max: 11.1cm	13.5cm
6 months	TBBCo-02	Min: 13cm Max: 16.3cm	Min: 9.9cm Max: 12.3cm	17.3cm
18 months	TBBCo-03	Min: 14.4cm Max: 18.1cm	Min: 10.8cm Max: 13.4cm	21.3cm
3 years	TBBCo-04	Min: 15.3cm Max: 19.3cm	Min: 11.7cm Max: 14.6cm	25.5cm
5 years	TBCoP-01	Min: 16.2cm Max: 20.5cm	Min: 12.2cm Max: 15.3cm	28.9cm
7 years	TBCoP-02	Min: 17.2cm Max: 21.8cm	Min: 12.6cm Max: 15.8cm	32.4cm
9 years	TBCoP-03	Min: 18.3cm Max: 23.2cm	Min: 13.1cm Max: 16.4cm	36.0cm
11 years	TBCoP-04	Min: 19.9cm Max: 25.3cm	Min: 13.5cm Max: 17cm	39.7cm

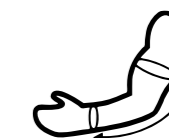

Promedics Aspen Paediatric Collar

- Specially designed for infants and pediatric patients
- Engineered to provide substantial motion restriction without producing painful pressure points that can lead to skin breakdown
- All contact surfaces are cushioned with cotton-lined, breathable foam padding for ultimate comfort
- Unique Cushion Flex Tabs™ enable a customised fit
- PD4 and PD5 feature an occipital support strap that when adjusted, provide a custom cradle for the back of the head



Aspen Paediatric Collar Set Product Code	Aspen Paediatric Collar Product Code	Size	Age	Measurements	Weight
983192	983190	PD1	1 - 18 months	53cm - 84cm	11 - 29lbs
983197	983195	PD2	9 - 24 months	74cm - 94cm	22 - 33lbs
983126	983106	PD3	1 - 3 years	384cm - 102cm	24 - 36lbs
983122	983102	PD4	2 - 5 years	89cm - 114cm	26 - 42lbs
983124	983104	PD5	3 - 6 years	94cm - 122cm	27 - 54lbs

Aspen Paediatric Collar Replacement Pad Set

Product Code
983199

Promedics Aspen® Sierra Universal Paediatric Collar™

- Fits the vast majority of patients without adjustment
- Helps reduce inventory requirements
- Unique design provides comfort, motion restriction and protection
- Designed from closed cell foam
- Excellent for use as a shower collar



Promedics Aspen® Sierra Universal Paediatric Collar™

Product Code
983150

Promedics Aspen Paediatric CTO Collar

- Cervical and upper thoracic spinal brace
- Combines highly effective immobilisation of the cervical and upper thoracic spine
- Research has shown increasing immobilisation, going from a stand alone cervical collar to a two-post device and then onto a four-post orthosis
- Offers 'step-down' alteration for ongoing rehabilitation therapy
- Improves comfort and patient compliance
- Unlimited adjustability
- MRI compatible
- Replacement liners available



Aspen Paediatric CTO Collar Description	Product Code	Size
Aspen Paediatric CTO Collar	983301	Short or Regular
Replacement Liner	983302	N/A

Ossur Miami Jr®

- Innovative collar designed exclusively for children 12 and under
- Four true paediatric sizes ensure optimal airway and the upper cervical spine immobilisation
- Sized according to the Broselow-Luten Colour-Coding System
- Sorbatex™ II pads make the collar 'skin friendly' and protect skin integrity during extended wear
- Replacement pads available

Miami Jr® Cervical Collar Size	Product Code Collar	Product Code Collar Set	Replacement Pads
0 - 6 months	MJ-P0	MJR-P0	MJP-P0
6 months - 2 years	MJ-P1	MJR-P1	MJP-P1
2 - 6 years	MJ-P2	MJR-P2	MJP-P2
6 - 12 years	MJ-P3	MJR-P3	MJP-P3



Ossur Papose

- An innovative design for newborns up to 3 months
- This true cervical spine immobiliser cradles the baby's body, securely while gently immobilising the head and spine in the proper anatomical airway and spinal alignment to help achieve optimal patient outcome while allowing for continued intimacy between caregiver and child



Ossur Papose

Description	Size	Product Code
Ossur Papoose & PO Front	One Size	PA-100
Ossur Papoose & PO Front With Replacement Pads	One Size	PAR-100

KSA Paediatric Headmaster Collar

- Provides excellent support and control
- Open design is cool and unobtrusive to wear
- Bend manually for custom fit
- Soft rear strap with hook-and-loop closure
- Optional Extension Neck Pad attach to inside rear of neck strap for extension support
- Neck pad and Neck Extension Pads are fully cloth-covered
- Measure from center of chin to corner of jaw. If measurements fall between sizes, choose smaller size: Infant: 2-1/2", Child: 3", Junior: 3-1/2"



KSA Paediatric Headmaster Collar - Latex Free

Size	Product Code
Infant	2970002669/52368I
Child	2970002670/52368C
Junior	2970002671/52368J

KSA Paediatric Headmaster Collar - Neck Pads

Size	Product Code
Child	2970002588/52170C
Junior	2970002587/52170S/J

Brace Orthopaedic MKS® Paediatric Thorecta

- Functions according to the 3-Point-Principle
- Adjustable, stable aluminium profiles
- All section parts are padded
- Individual strap course
- Compression padding for the waist
- Additional firm thorax support



MKS® Paediatric Thorecta

Size	Product Code	Body Circumference	Height of Front Piece	Height of Back Piece
Bambini	731E	50 - 70cm	Maximal 34cm	Maximal 26cm
Junior	731D	60 - 80cm	Maximal 40cm	Maximal 33cm

Brace Orthopaedic MKS® Paediatric Thorecta Plus

- Functions according to the 3-Point-Principle
- Adjustable, stable aluminium profiles
- All section parts are padded
- Individual strap course
- Compression padding for the waist
- Additional firm thorax support



MKS® Paediatric Thorecta Plus

Size	Product Code	Body Circumference	Height of Front Piece	Height of Back Piece
Bambini	751E	50 - 70cm	Maximal 34cm	Maximal 38cm
Junior	751D	60 - 80cm	Maximal 40cm	Maximal 48cm

Brace Orthopaedic MKS® Paediatric Osteo

- Functions according to the reclination principle
- Semi-elastic bandaging material
- Lateral reinforcing stays
- Firm abdominal piece with hook and loop fastener
- Adjustable back plate with incorporated aluminium profile
- Individual strap course
- Reclination straps

Body Belt Plus + Osteo Back Plate = Osteo Plus

To make a modular Osteo Plus TLSO solution please choose the appropriate belt and back plate options from the following charts.

MKS® Paediatric Thorecta

Size	Product Code	Body Circumference	Abdominal Height	Height of Back Piece	Product Code
Bambini	582-000NS-S	50 - 60cm	14cm	XXS (34cm)	762-064-S
Junior	582-001NS-S	60 - 70cm	14cm	XS (42cm)	762-065-S



Brace Orthopaedic MKS® Paediatric Osteo Plus

- Functions according to the reclination principle
- Semi-elastic bandaging material
- Lateral reinforcing stays
- Firm abdominal piece with hook and loop fastener
- Adjustable back plate with incorporated aluminium profile
- Individual strap course
- Reclination straps

Body Belt Plus + Osteo Back Plate = Osteo Plus

To make a modular Osteo Plus TLSO solution please choose the appropriate belt and back plate options from the following charts.

MKS® Paediatric Thorecta Plus

Size	Product Code	Body Circumference	Abdominal Height	Height of Back Piece	Product Code
Bambini	582-200NS-S	50 - 60cm	14cm	XXS (34cm)	762-064-S
Junior	582-201NS-S	60 - 70cm	14cm	XS (42cm)	762-065-S



How to measure:

One frontal measurement is required which determines the height of the back part - from the sternal angle (2cm below sterno/clavicular joint) to 2cm above symphysis pubis.



+44 (0) 114 2637900 | orthoticscs@blatchford.co.uk
Blatchford Limited, 30 Atlas Way, Sheffield, S4 7QQ, United Kingdom.

@blatchfordgrp | blatchfordmobility.com

504154884 936605 Iss16 05/24. Information correct at time of print.

Blatchford 